

KOBELCO

HYDRAULIC CRAWLER CRANE

7120

Model: 7120-1F

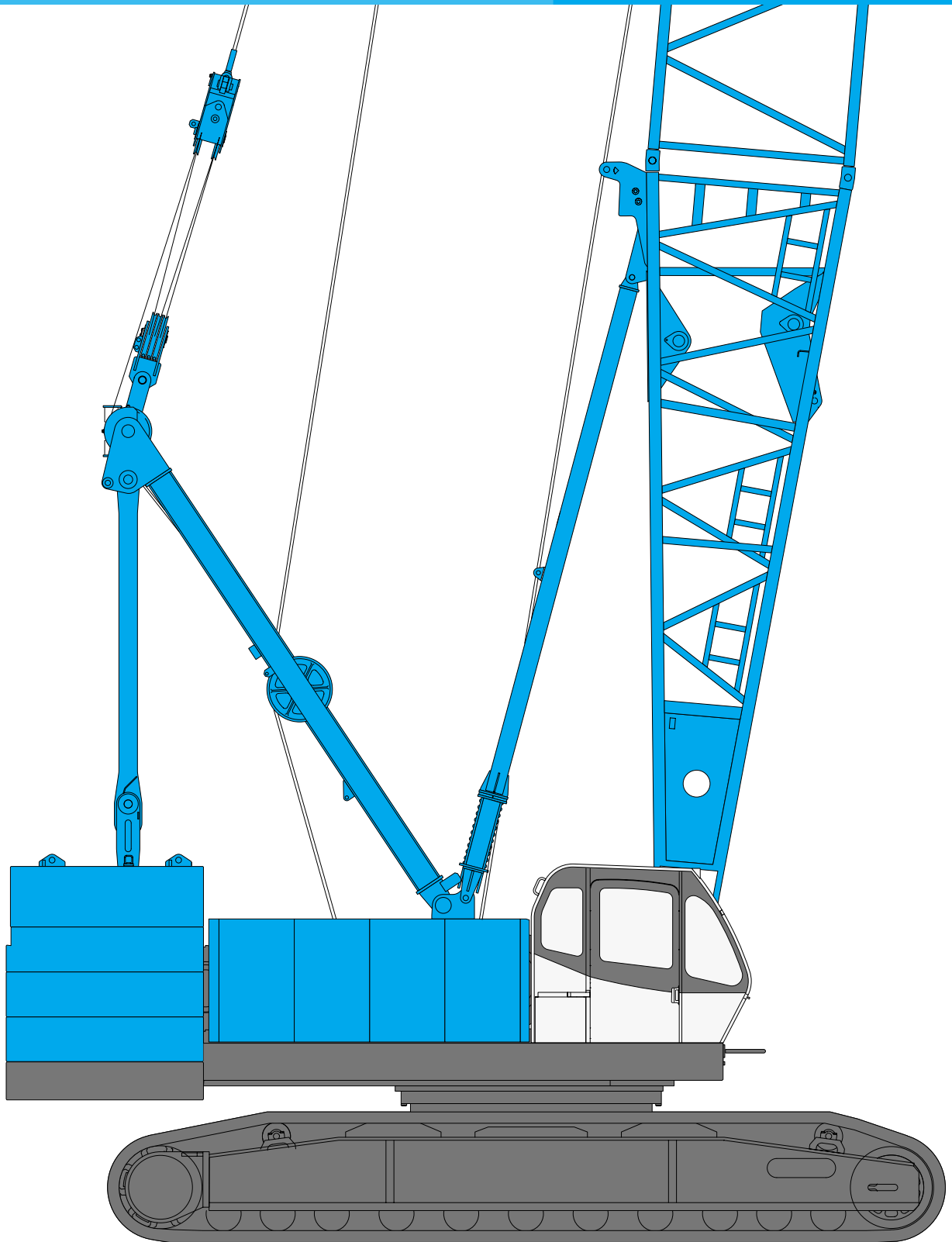

Max. Lifting Capacity: 120 t x 5.0 m
Max. Crane Boom Length: 61.0 m
Max. Long Boom Length: 79.2 m
Max. Fixed Jib Combination: 61.0 + 30.5 m
Max. Tower Jib Combination: 51.7 + 44.2 m

CONFIGURATION

Crane Boom

Max. Lifting Capacity:
120 metric ton x 5.0 m
Max. Boom Length:
61.0 m



Long Boom

Max. Lifting Capacity:
24 metric ton x 16.0 m
Max. Boom Length:
79.2 m



Fixed Jib

Max. Lifting Capacity:
12 metric ton x 28.0 m
Max. Combination:
61.0 m + 30.5 m

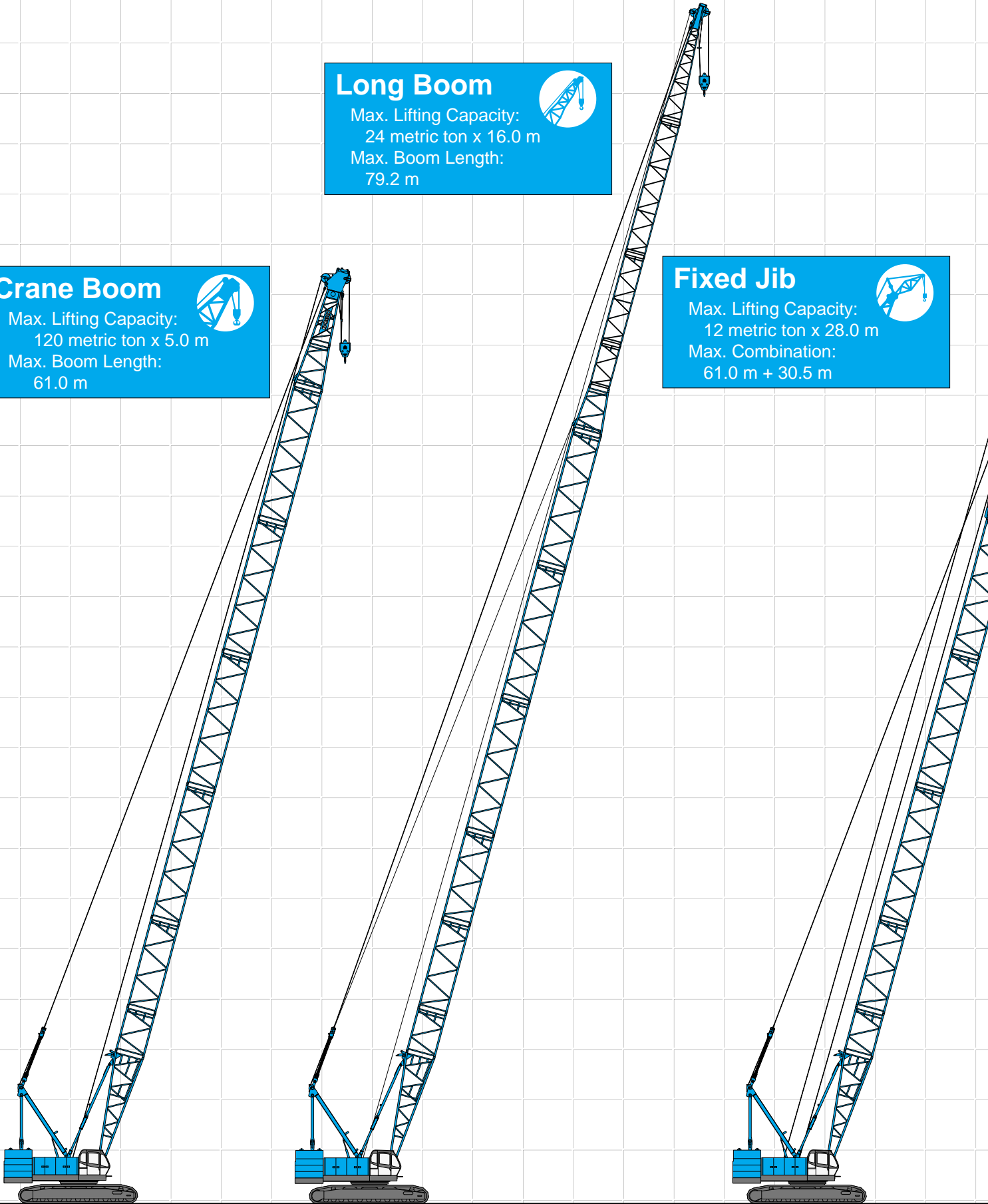

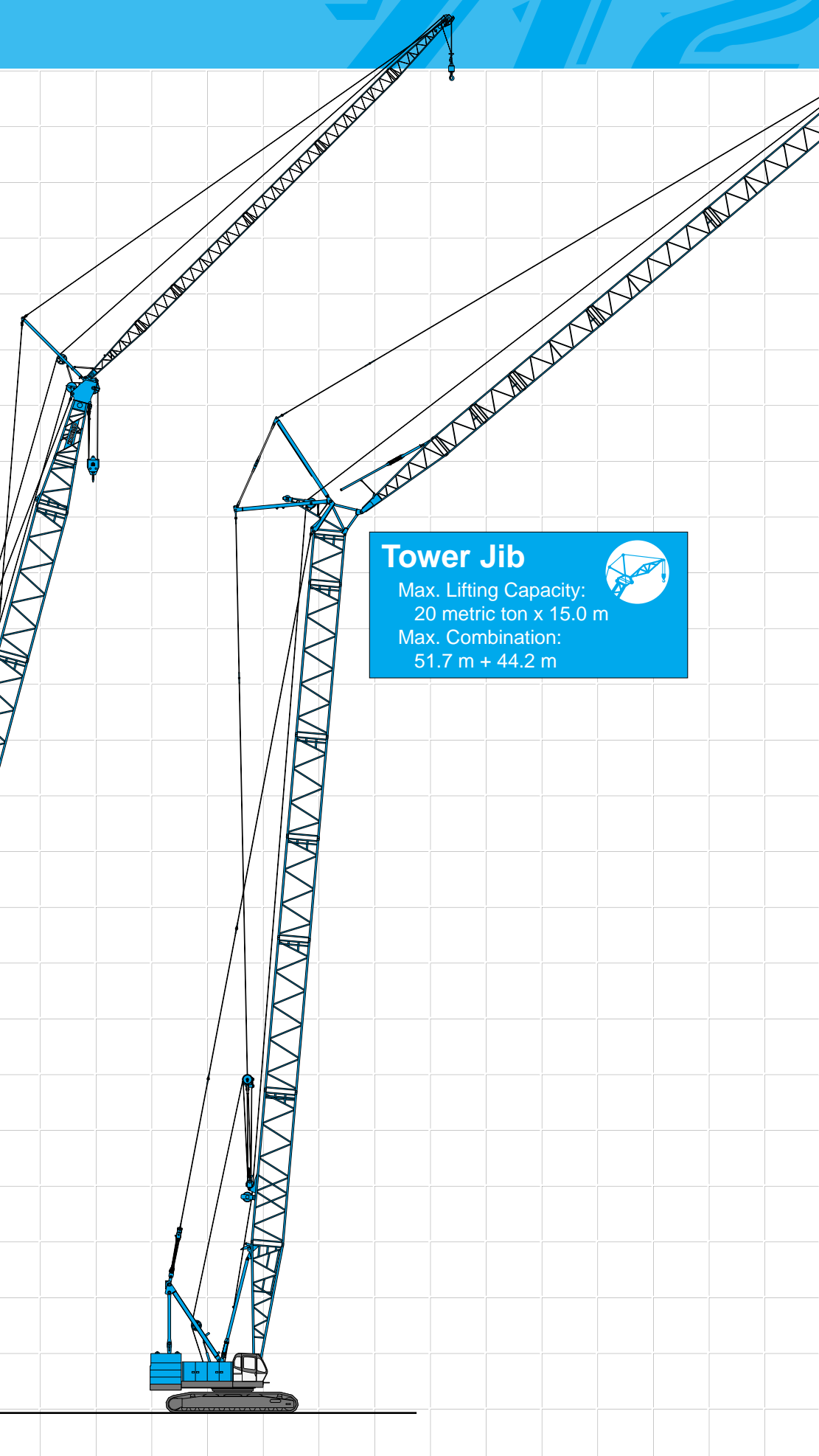

Tower Jib

Max. Lifting Capacity:
20 metric ton x 15.0 m

Max. Combination:
51.7 m + 44.2 m



CONTENTS

- Configuration 1
- Specifications 3
- General Dimensions 5
- Boom and Jib Arrangements**
- Crane Boom Arrangements 7
- Fixed Jib Arrangements 7
- Long Boom Arrangements 8
- Tower Arrangements 9
- Tower Jib Arrangements 9
- Working Ranges and Lifting Capacities**
- Crane Boom Working Ranges 11
- Crane Boom Lifting Capacity 12
- Auxiliary Sheave Lifting Capacity for Crane Boom 13
- Long Boom Working Ranges 14
- Long Boom Lifting Capacity 15
- Auxiliary Sheave Lifting Capacity for Long Boom 15
- Fixed Jib Working Ranges 16
- Fixed Jib Lifting Capacities 17
- Tower Jib Working Ranges 19
- Tower Jib Lifting Capacities 21
- Parts and Attachments ... 27

SPECIFICATIONS



Power Plant

Model: Hino diesel engine P11C-UN
Type: Water-cooled, direct fuel injection, with turbocharger
Complies with NRMM (Europe) Stage IIIA and US EPA Tier III.
Displacement: 10.520 liters
Rated Power: 247 kW at 2,000 min⁻¹ {rpm} (ISO)
Max. torque: 1,300 N·m/1,500 min⁻¹
Cooling system: Liquid, recirculating bypass
Starter: 24 V/6.0 kW
Radiator: Corrugated type core, thermostatically controlled
Air cleaner: Dry type with replaceable paper element
Throttle: Electric throttle control, twist grip type
Fuel filter: Replaceable paper element
Batteries: Two 12V, 136 Ah/5HR capacity batteries, series connected.
Fuel tank capacity: 400 liters



Hydraulic System

Four variable displacement piston pumps are driven by heavy-duty pump drive. Two of variable displacement pumps are used in the main hook hoist circuit, auxiliary hook hoist circuit and each propel circuit. One of the other two pumps is used in the swing circuit. The other is used in the boom hoist circuit and third hoist circuit.

Control: Full-flow hydraulic control system for infinitely variable pressure to front and rear drums, boom hoist brakes and clutches. Controls respond instantly to the touch, delivering smooth function operation.

Cooling: Oil-to-air heat exchanger (plate-fin type)

Filtration: Full-flow and bypass type with replaceable element

Electrical system: All wiring corded for easy servicing, individual fused branch circuits.

Max. relief valve pressure:

Load hoist, boom hoist and propel system:

31.9 MPa {325 kgf/cm²}

Swing system: 27.5 MPa {280 kgf/cm²}

Control system: 7.0 MPa {71 kgf/cm²}

Reservoir capacity: 535 liters



Boom Hoisting System

Powered by a hydraulic motor through a planetary reducer.

Brake: A spring-set, hydraulically released multiple-disc brake is mounted on the boom hoist motor and operated through a counter-balance valve.

Drum lock: External ratchet for locking drum.

Drum: Single drum, grooved for 20 mm dia. wire rope.

Line speed: Single line on first drum layer
Hoisting/Lowering: 48 to 2 m/min

Diameter of wire ropes

Boom guy line: 30 mm

Boom hoist reeving: 12 parts of 20 mm dia. high strength wire rope

Boom backstops: Telescopic type with spring bumper
Required for all boom lengths



Load Hoist System

Front and rear drums for load hoist powered by a hydraulic variable plunger motors, driven through planetary reducers.

Negative Brake: A spring-set, hydraulically released multiple-disc brake is mounted on the hoist motor and operated through a counter-balance valve. (Positive free fall brake is optional item.)

Drum lock: External ratchet for locking drum.

Drums:

Front drum:

666 mm P.C.D. x 672 mm Lg. wide drum, grooved for 26 mm wire rope. Rope capacity is 275 m working length and 350 m storage length.

Rear drum:

666 mm P.C.D. x 672 mm Lg. wide drum, grooved for 26 mm wire rope. Rope capacity is 255 m working length and 350 m storage length.

Note: Rope lengths listed above denote drum capacity and may differ from actual rope lengths supplied when machinery is shipped.

Line speed: Single line on the first drum layer

Hoisting/Lowering: 120 to 3 m/min

Tower Jib Hoisting/Lowering: 60 to 3 m/min (Rear drum)

Line Pull (Single-line):

Rated line pull: 118 kN {12.0 tf}



Swing System

Swing unit is powered by hydraulic motor driving spur gear through planetary reducer, the swing system provides 360° rotation.

Swing brakes: A spring-set, hydraulically released multiple-disc brake is mounted on swing motor.

Swing circle: Single-row ball bearing with an integral internally cut swing gear.

Swing lock: Manually, four position lock for transportation

Swing speed: 2.1 min⁻¹ {rpm}



Upper Structure

Torsion-free precision machined upper frame. All components are located clearly and service friendly. Engine with low noise level.

Counterweight: 52.3 ton



Cab & Control

Totally enclosed, full vision cab with safety glass, fully adjustable, high backed seat with a head-rest and armrests, and intermittent wiper and window washer (skylight and front window).

Cab fittings:

Air conditioner, convenient compartment (for tool), cup holder, ashtray, cigarette lighter, sun visor, roof blind, tinted glass, floor mat, foot-rest, shoe tray

Controls:

Four adjustable levers for front drum, rear drum, boom drum and swing controls



Lower Structure

Steel-welded carbody with axles. Crawler assemblies are designed with quick disconnect feature for individual removal as a unit from axles. Crawler belt tension is maintained by hydraulic jack force on the track-adjusting bearing block.

Crawler drive: Independent hydraulic propel drive is built into each crawler side frame. Each drive consists of a hydraulic motor propelling a driving tumbler through a planetary gear box. Hydraulic motor and gear box are built into the crawler side frame within the shoe width.

Crawler brakes: Spring-set, hydraulically released parking brakes are built into each propel drive.

Steering mechanism: A hydraulic propel system provides both skid steering (driving one track only) and counter-rotating steering (driving each track in opposite directions).

Track rollers: Sealed track rollers for maintenance-free operation.

Shoes (flat): 60 shoes, 910 mm wide each crawler

Max. travel speed: 1.3/0.9 km/h

Max. gradeability: 30%



Weight

Including upper and lower machine, 52.3 ton counterweight, basic boom (or basic tower + basic tower jib), hook, and other accessories.

Specification	Weight	Ground pressure
Crane boom	Approx. 120 ton,	94 kPa {0.96 kgf/cm ² }
Tower Jib	Approx. 130 ton,	102 kPa {1.04 kgf/cm ² }



Attachment

Boom and Jib:

Welded lattice construction using tubular, high-tensile steel chords with pin connections between sections.

Boom and Jib Length

	Min. Length (Min. Combination)	Max. Length (Max. Combination)
Crane Boom	15.2 m	61.0 m
Long Boom	61.0 m	79.2 m
Fixed Jib	24.4 m + 12.2 m	61.0 m + 30.5 m
Tower Jib	30.4 m + 22.9 m	51.7 m + 44.2 m

Main Specifications (Model: 7120-1F)

Crane Boom	
Max. Lifting Capacity	120 t/5.0 m
Max. Length	61.0 m
Long Boom	
Max. Lifting Capacity	24 t/16.0 m
Max. Length	79.2 m
Fixed Jib	
Max. Lifting Capacity	12 t/28.0 m
Max. Combination	61.0 m + 30.5 m
Tower Jib	
Max. Lifting Capacity	20 t/15.0 m
Max. Combination	51.7 m + 44.2 m
Tower Angle	60° ~ 90°
Main & Aux. Winch	
Max. Line Speed	120 m/min (1st layer)
Rated Line Pull (Single-line)	118 kN {12.0 tf}
Wire Rope Diameter	26 mm
Wire Rope Length	Crane 275 m (Main) 255 m (Aux.)
	Tower 290 m (Main) 145 m (Aux.)
Brake Type	Spring set hydraulically released multiple disc brake(Negative)
Free-Fall Brake Type	Wet-type multiple disc brake (Optional)

Working Speed

Swing Speed	2.1 min ⁻¹ {rpm}
Travel Speed	1.3/0.9 km/h

Power Plant

Model	Hino P11C-UN
Engine Output	247 kW/2,000 min ⁻¹ {rpm}
Fuel Tank Capacity	400 liters

Hydraulic System

Main Pumps	4 variable displacement
Max. Pressure	31.9 MPa {325 kgf/cm ² }
Hydraulic Tank Capacity	535 liters

Weight

Operating Weight*	Approx. 120 t
Ground Pressure*	94 kPa {0.96 kgf/cm ² }
Counterweight	52.3 t
Transport Weight**	Approx. 36.8 t

* Including upper and lower machine, 52.3 ton counterweight, basic boom, hook, and other accessories.

** Base machine with boom base, gantry, carbody, lower spreader and upper spreader.

Units are SI units. {} indicates conventional units.

GENERAL DIMENSIONS

Crane Boom

(Unit: mm)

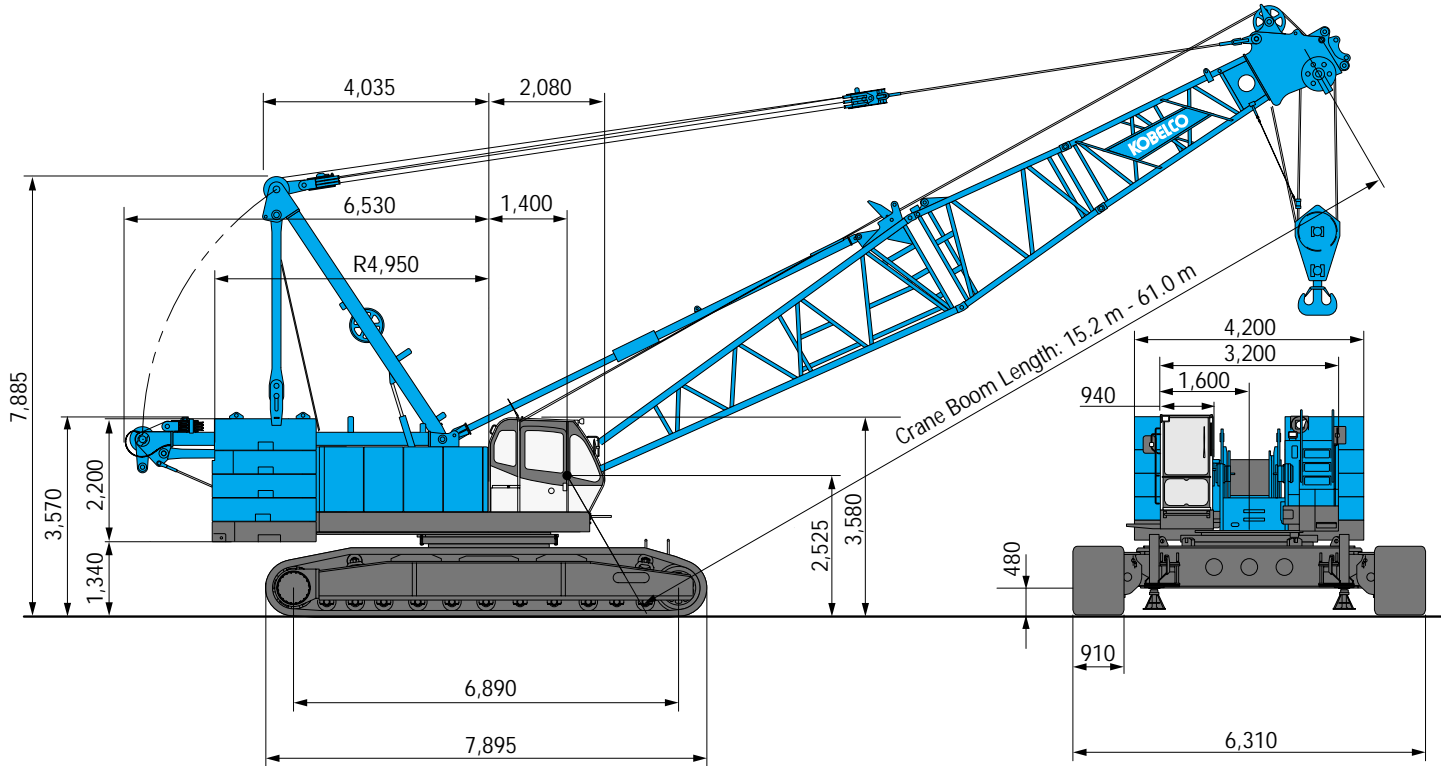

Limit of Hook Lifting

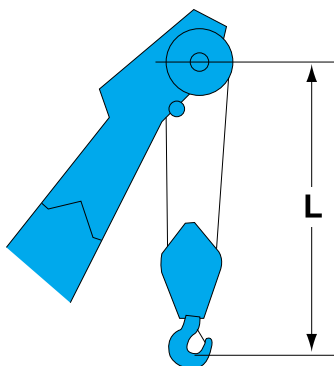

Hook	L
120 t hook	5.0 m
70 t hook	5.0 m
35 t hook	5.0 m

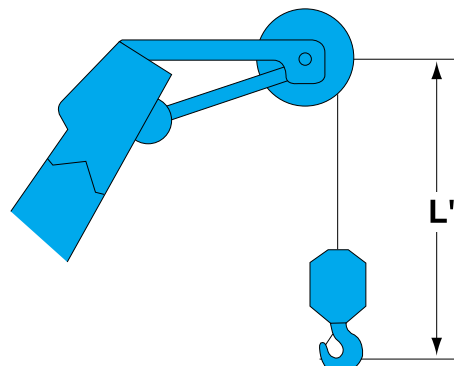

Hook	L'
12 t ball hook	4.2 m

Tower Jib

(Unit: mm)

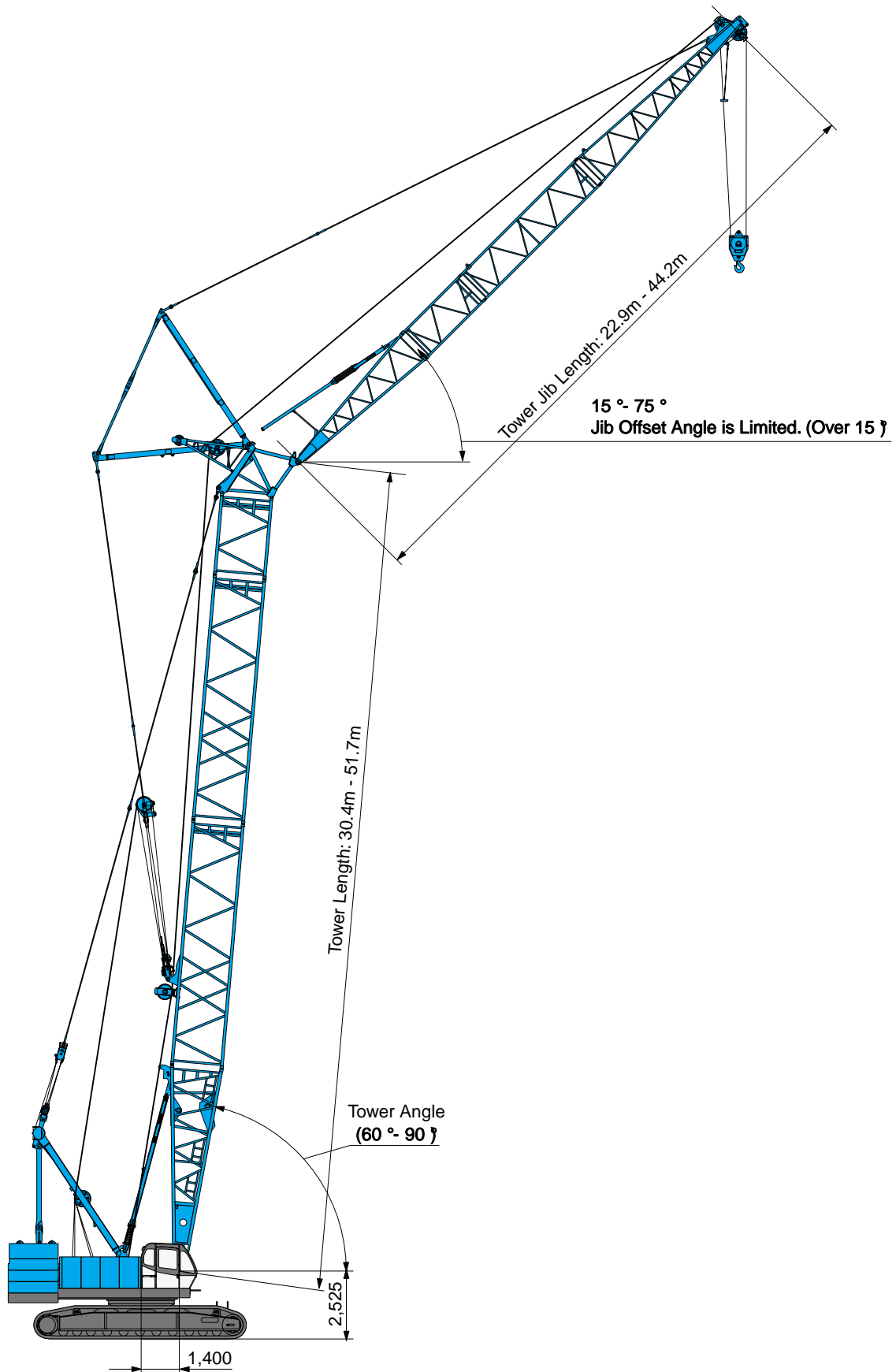

BOOM AND JIB ARRANGEMENTS

Crane Boom Arrangements

Boom length m (ft)	Boom arrangement
15.2 (50)	
18.3 (60)	
21.3 (70)	
24.4 (80)	
27.4 (90)	
30.5 (100)	
33.5 (110)	
36.6 (120)	
39.6 (130)	

Boom length m (ft)	Boom arrangement
42.7 (140)	
45.7 (150)	
48.8 (160)	
51.8 (170)	
54.9 (180)	
57.9 (190)	
61.0 (200)	

Symbol	Boom Length	Remarks
	7.6 m	Boom Base
	4.6 m	Boom Top
	3.0 m	Tapered Boom
	3.0 m	Insert Boom
	6.1 m	Insert Boom
	9.1 m	Insert Boom

↗ mark shows the guy line installing position when the fixed jib is used.

※ Indicates the most flexible combination of insert booms, which can be modified to form all shorter boom arrangements.

Fixed Jib Arrangements

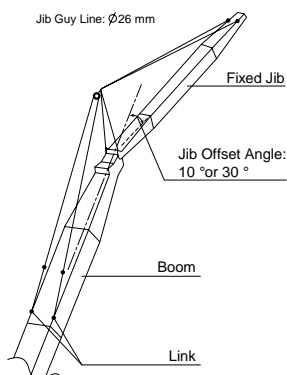

Crane boom length	Jib length m (ft)	Jib arrangement	Jib offset angle
24.4 m } 61.0 m	12.2(40)		30 °
	18.3 (60)		10° / 30°
	24.4 (80)		10° / 30°
	30.5 (100)		10° / 30°

Symbol	Jib Length	Remarks
	4.6 m	Jib Base
	4.6 m	Jib Top
	3.0 m	Insert Jib
	6.1 m	Insert Jib

※ The jib length of 12.2 m is based on the only setting of 30 degrees offset.

Long Boom Arrangements

Boom length m (ft)	Long Boom arrangement
61.0 (200)	
64.0 (210)	
67.1 (220)	
70.1 (230)	
73.2 (240)	
76.2 (250)	
79.2 (260)	

Symbol	Long Boom Length	Remarks
	7.6 m	Boom Base
	7.6 m	Tower Jib Top
	3.0 m	Insert Boom
	6.1 m	Insert Boom
	9.1 m	Insert Boom
	3.0 m	Tapered Boom
	3.0 m	Relay Jib
	3.0 m	Tower Insert Jib
	6.1 m	Tower Insert Jib
	9.1 m	Tower Insert Jib

※ Indicates the most flexible combination of insert long booms, which can be modified to form all shorter long boom arrangements.

Tower Arrangements

Tower length m (ft)	Tower arrangement
30.4 (100)	
33.4 (110)	
36.5 (120)	
39.5 (130)	
42.5 (140)	
45.6 (150)	
48.6 (160)	
51.7 (170)	

Symbol	Tower Length	Remarks
	7.6 m	Boom Base
	1.4 m	Tower Cap
	3.0 m	Insert Boom
	6.1 m	Insert Boom
	9.1 m	Insert Boom
	9.1 m	Special Insert Boom for Tower

※ Indicates the most flexible combination of insert tower booms, which can be modified to form all shorter tower boom arrangements.

9.1A should be basically used in tower, and it may be also used as insert boom for crane.

Tower Jib Arrangements

Jib length m (ft)	Jib arrangement
22.9 (75)	
25.9 (85)	
29.0 (95)	
32.0 (105)	
35.1 (115)	
38.1 (125)	
41.1 (135)	
44.2 (145)	

Symbol	Tower Jib Length	Remarks
	6.1 m	Tower Jib Base
	7.6 m	Tower Jib Top
	3.0 m	Relay Jib
	3.0 m	Tower Insert Jib
	6.1 m	Tower Insert Jib
	9.1 m	Tower Insert Jib

※ Indicates the most flexible combination of insert tower jibs, which can be modified to form all shorter tower jib arrangements.
mark indicates position where cable rollers attached

Tower and Jib Combinations and Allowable Tower Angle

Tower length \ Jib length	22.9 m	25.9 m	29.0 m	32.0 m	35.1 m	38.1 m	41.1 m	44.2 m	Pillow plate
30.4 m	90 °60 °	90 °60 °	—	—	—	—	—	—	—
33.4 m	90 °60 °	90 °60 °	90 °60 °	90 °60 °	—	—	—	—	—
36.5 m	90 °60 °	90 °60 °	90 °60 °	90 °60 °	—	—	—	—	—
39.5 m	90 °60 °	90 °60 °	90 °60 °	90 °60 °	90 °60 °	—	—	—	—
42.5 m	90 °60 °	90 °60 °	90 °60 °	90 °60 °	90 °60 °	90 °60 °	—	—	—
45.6 m	90 °60 °	90 °60 °	90 °60 °	90 °60 °	90 °60 °	90 °60 °	90 °70 °	—	—
48.6 m	90 °60 °	90 °60 °	90 °60 °	90 °60 °	90 °60 °	90 °70 °	90 °70 °	90 °70 °	—
51.7 m	90 °60 °	90 °60 °	90 °60 °	90 °60 °	90 °70 °	90 °70 °	90 °70 °	90 °70 °	Need
Hook	35 ton hook	○	○	○	○	○	○	○	X
	Ball hook	×	○	○	○	○	○	○	

○ : Available
× : Not available







Hook Blocks

A range of hook blocks can be specified, each with a safety latch.

Hooks	Weight (kg)	No. of sheaves	No. of lines and max. rated loads (tons)				
			1	2	3	4	5
120-ton	1,700	5	-	-	-	48.0	60.0
70-ton	1,200	3	-	24.0	36.0	48.0	60.0
35-ton	900	1	-	24.0	35.0	-	-
12-ton ball hook	450	0	12.0	-	-	-	-

Hooks	Weight (kg)	No. of sheaves	No. of lines and max. rated loads (tons)				
			6	7	8	9	10
120-ton	1,700	5	72.0	84.0	96.0	108.0	120.0
70-ton	1,200	3	70.0	-	-	-	-
35-ton	900	1	-	-	-	-	-
12-ton ball hook	450	0	-	-	-	-	-

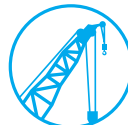
Symbols for Attachments:

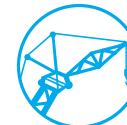
					
Crane Boom	Auxiliary Sheave for Crane Boom	Long Boom	Auxiliary Sheave for Long Boom	Fixed Jib	Tower Jib

WORKING RANGES AND LIFTING CAPACITIES

Crane Boom Working Ranges

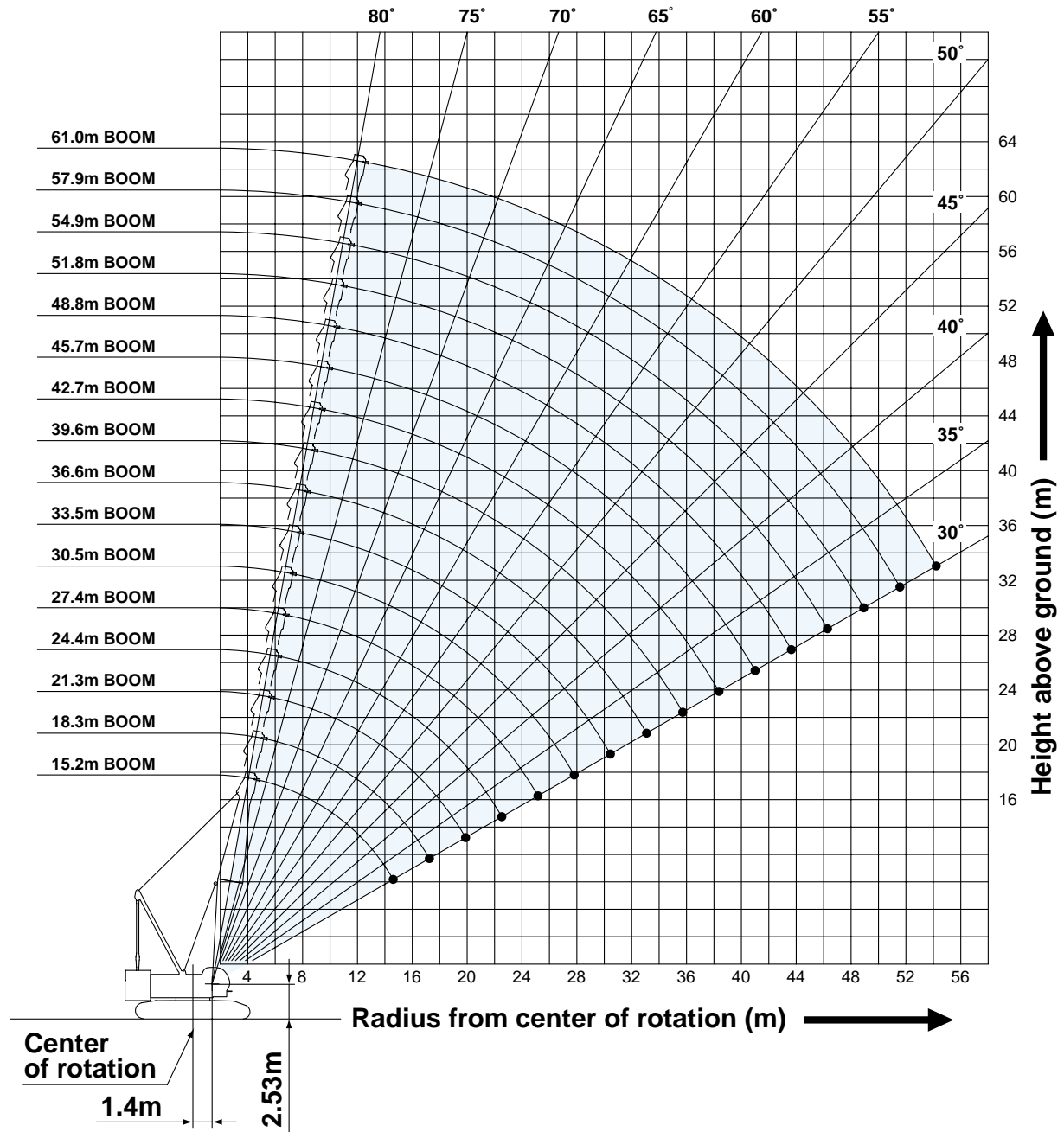

NOTES:

- Ratings according to Japanese Construction Codes for Mobile Cranes and Japanese Safety Ordinance on Cranes, etc.
- Ratings in metric tons for 360° working area.
- Operating radius is the horizontal distance from center of rotation to a vertical line through the center of gravity of the load.
- Weight of hook block(s), slings and other load handling accessories is included in rated load. Their total weight must be subtracted from rated load to obtain weight that can be lifted.
- Ratings shown are based on freely suspended loads and make no allowance for such factors as wind effect on lifted load, ground conditions out-of-level, operating speeds or any other condition that could be detrimental to the safe operation of this equipment. Operator, therefore, has the responsibility to judge the existing conditions and reduce lifted loads and operating speeds accordingly.
- Ratings are for operation on a firm and level surface.
- At radii and boom lengths where no ratings are shown on chart, operation is not intended nor approved.
- Boom inserts and guy lines must be arranged as shown in the "Operator's Manual".
- Boom hoist reeving is 12 part line.
- Gantry must be in raised position for all conditions.
- Boom backstops are required for all boom lengths.
- Ratings shown in are determined by the strength of the boom or other structural component.
- Instruction in the "Operator's Manual" must be strictly observed when operating the machine.
- Crane boom ratings: Deduct weight of main hook block, slings, and all other load handling accessories from crane boom ratings shown.
- Auxiliary sheave ratings for crane boom: Deduct weight of ball hook, slings, and all other load handling accessories from auxiliary sheave ratings shown.
- Crane boom lengths for auxiliary sheave mounting are 15.2 m to 61.0 m.
- Crane boom ratings with auxiliary sheave: Deduct 0.8 ton from crane boom ratings shown. Minimum rated loads must exceed 2.0 ton.



HYDRAULIC CRAWLER CRANE 7120

Crane Boom Lifting Capacity

Unit: metric ton

Counterweight: 52.3 t

Working radius (m)	Boom Length (m)												Working radius (m)	
	15.2	18.3	21.3	24.4	27.4	30.5	33.5	36.6	39.6	42.7	45.7	48.8		
4.5	4.5 m/120.0													4.5
5.0	120.0	5.1 m/108.0	5.6 m/96.0											5.0
6.0	100.0	99.8	94.9	6.1 m/84.0	6.7 m/74.6									6.0
7.0	85.7	85.5	85.3	81.5	73.7	7.2 m/66.4	7.7 m/59.4							7.0
8.0	73.7	73.6	73.5	73.5	71.3	64.7	58.9	8.2 m/53.6	8.8 m/48.0					8.0
9.0	61.5	61.3	61.2	61.1	61.0	60.9	57.2	52.5	48.0	9.3 m/43.5	9.8 m/39.6			9.0
10.0	52.6	52.5	52.3	52.2	52.1	52.0	52.0	51.2	46.8	42.8	39.5	10.4 m/36.0		10.0
12.0	40.6	40.5	40.3	40.2	40.0	40.0	39.9	39.7	39.7	39.5	37.8	34.7		12.0
14.0	33.0	32.8	32.6	32.5	32.3	32.3	32.2	32.0	31.9	31.8	31.6	31.6		14.0
16.0	14.9 m/29.1	27.5	27.3	27.2	26.9	26.9	26.8	26.6	26.5	26.4	26.2	26.1		16.0
18.0		17.5 m/24.5	23.3	23.2	23.0	22.9	22.8	22.6	22.5	22.4	22.2	22.1		18.0
20.0			20.3	20.2	20.0	19.9	19.8	19.5	19.5	19.3	19.1	19.1		20.0
22.0			20.1 m/20.2	17.8	17.6	17.5	17.4	17.1	17.1	16.9	16.7	16.6		22.0
24.0				22.8 m/17.1	15.6	15.5	15.4	15.2	15.1	14.9	14.7	14.7		24.0
26.0					25.4 m/14.5	13.9	13.8	13.6	13.5	13.3	13.1	13.0		26.0
28.0						12.6	12.5	12.2	12.1	12.0	11.7	11.7		28.0
30.0							11.3	11.1	11.0	10.8	10.6	10.5		30.0
32.0							30.7 m/11.0	10.1	10.0	9.8	9.6	9.5		32.0
34.0								33.3 m/9.5	9.1	8.9	8.7	8.6		34.0
36.0									8.4	8.2	8.0	7.9		36.0
38.0										7.5	7.3	7.2		38.0
40.0										38.6 m/7.4	6.7	6.6		40.0
42.0											41.2 m/6.4	6.1		42.0
44.0												43.9 m/5.6		44.0
Reeves	10	9	8	7	7	6	5	5	4	4	4	3		Reeves

Working radius (m)	Boom Length (m)				Working radius (m)
	51.8	54.9	57.9	61.0	
10.0	10.9 m/32.1	11.4 m/29.4			10.0
12.0	31.4	29.0	26.9	12.5 m/24.0	12.0
14.0	30.1	27.9	25.9	23.5	14.0
16.0	26.0	25.8	24.9	22.8	16.0
18.0	22.0	21.8	21.6	21.4	18.0
20.0	18.9	18.7	18.6	18.5	20.0
22.0	16.5	16.3	16.1	16.0	22.0
24.0	14.5	14.3	14.1	14.1	24.0
26.0	12.9	12.7	12.5	12.4	26.0
28.0	11.5	11.3	11.1	11.0	28.0
30.0	10.3	10.1	10.0	9.9	30.0
32.0	9.3	9.1	9.0	8.9	32.0
34.0	8.5	8.2	8.1	8.0	34.0
36.0	7.7	7.5	7.3	7.2	36.0
38.0	7.0	6.8	6.6	6.5	38.0
40.0	6.4	6.2	6.0	5.9	40.0
42.0	5.9	5.7	5.5	5.4	42.0
44.0	5.4	5.2	5.0	4.9	44.0
46.0	5.0	4.7	4.6	4.4	46.0
48.0	46.5 m/4.9	4.3	4.1	3.9	48.0
50.0		49.2 m/4.1	3.7	3.5	50.0
52.0			51.8 m/3.3	3.1	52.0
54.0				2.7	54.0
56.0				54.4 m/2.7	56.0
Reeves	3	3	3	2	Reeves

Note:

Ratings according to Japanese Construction Codes for Mobile Cranes and Japanese Safety Ordinance on Cranes, etc.

Ratings shown in are determined by the strength of the boom or other structural components.

Refer to notes P11.



Auxiliary Sheave Lifting Capacity for Crane Boom (Without Main Hook)

Unit: metric ton

Counterweight: 52.3 t

Working radius (m) \ Boom Length (m)	15.2	18.3	21.3	24.4	27.4	30.5	33.5	36.6	39.6	42.7	45.7	Working radius (m) \ Boom Length (m)
4.5												4.5
5.0	5.3m/12.0	5.8m/12.0										5.0
6.0	12.0	12.0	6.3m/12.0	6.9m/12.0								6.0
7.0	12.0	12.0	12.0	12.0	7.4m/12.0	7.9m/12.0						7.0
8.0	12.0	12.0	12.0	12.0	12.0	12.0	8.4m/12.0					8.0
9.0	12.0	12.0	12.0	12.0	12.0	12.0	12.0	12.0	9.5m/12.0			9.0
10.0	12.0	12.0	12.0	12.0	12.0	12.0	12.0	12.0	12.0	12.0	10.6m/12.0	10.0
12.0	12.0	12.0	12.0	12.0	12.0	12.0	12.0	12.0	12.0	12.0	12.0	12.0
14.0	12.0	12.0	12.0	12.0	12.0	12.0	12.0	12.0	12.0	12.0	12.0	14.0
16.0	12.0	12.0	12.0	12.0	12.0	12.0	12.0	12.0	12.0	12.0	12.0	16.0
18.0	16.2m/12.0	12.0	12.0	12.0	12.0	12.0	12.0	12.0	12.0	12.0	12.0	18.0
20.0		18.8m/12.0	12.0	12.0	12.0	12.0	12.0	12.0	12.0	12.0	12.0	20.0
22.0			21.5m/12.0	12.0	12.0	12.0	12.0	12.0	12.0	12.0	12.0	22.0
24.0				12.0	12.0	12.0	12.0	12.0	12.0	12.0	12.0	24.0
26.0				24.1m/12.0	12.0	12.0	12.0	12.0	12.0	12.0	12.0	26.0
28.0					26.7m/12.0	12.0	12.0	11.9	11.8	11.7	11.4	28.0
30.0						29.4m/12.0	11.0	10.8	10.7	10.5	10.3	30.0
32.0							10.1	9.8	9.7	9.5	9.3	32.0
34.0								8.9	8.8	8.6	8.4	34.0
36.0								34.7m/8.6	8.1	7.9	7.7	36.0
38.0									37.3m/7.6	7.2	7.0	38.0
40.0										39.9m/6.9	6.4	40.0
42.0											5.9	42.0
44.0											42.6m/5.8	44.0
Reeves	1	1	1	1	1	1	1	1	1	1	1	Reeves

Working radius (m) \ Boom Length (m)	48.8	51.8	54.9	57.9	61.0	Working radius (m) \ Boom Length (m)
10.0	11.1m/12.0	11.6m/12.0				10.0
12.0	12.0	12.0	12.2m/12.0	12.7m/12.0	13.2m/12.0	12.0
14.0	12.0	12.0	12.0	12.0	12.0	14.0
16.0	12.0	12.0	12.0	12.0	12.0	16.0
18.0	12.0	12.0	12.0	12.0	12.0	18.0
20.0	12.0	12.0	12.0	12.0	12.0	20.0
22.0	12.0	12.0	12.0	12.0	12.0	22.0
24.0	12.0	12.0	12.0	12.0	12.0	24.0
26.0	12.0	12.0	12.0	12.0	12.0	26.0
28.0	11.4	11.2	11.0	10.8	10.7	28.0
30.0	10.2	10.0	9.8	9.7	9.6	30.0
32.0	9.2	9.0	8.8	8.7	8.6	32.0
34.0	8.3	8.2	7.9	7.8	7.7	34.0
36.0	7.6	7.4	7.2	7.0	6.9	36.0
38.0	6.9	6.7	6.5	6.3	6.2	38.0
40.0	6.3	6.1	5.9	5.7	5.6	40.0
42.0	5.8	5.6	5.4	5.2	5.1	42.0
44.0	5.3	5.1	4.9	4.7	4.6	44.0
46.0	45.2m/5.0	4.7	4.4	4.3	4.1	46.0
48.0		47.9m/4.3	4.0	3.8	3.6	48.0
50.0			3.7	3.4	3.2	50.0
52.0			50.5m/3.6	3.0	2.8	52.0
54.0				53.1m/2.7	2.4	54.0
56.0					55.8m/2.0	56.0
Reeves	1	1	1	1	1	Reeves

Note:

Ratings according to Japanese Construction Codes for Mobile Cranes and Japanese Safety Ordinance on Cranes, etc.

Ratings shown in are determined by the strength of the boom or other structural components.

Refer to notes P11.

Long Boom Working Ranges

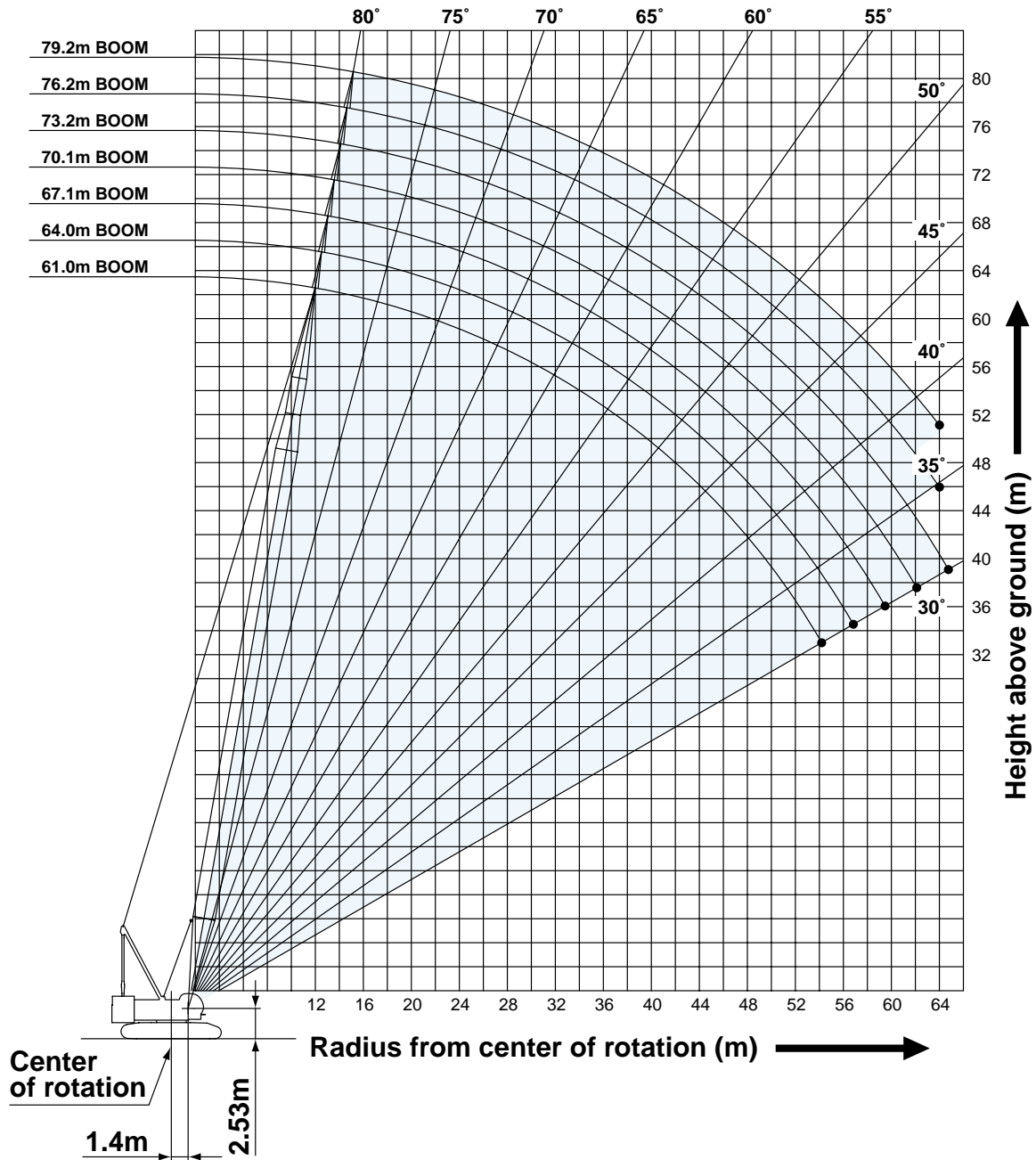

NOTES:

1. Ratings according to Japanese Construction Codes for Mobile Cranes and Japanese Safety Ordinance on Cranes, etc.
2. Ratings in metric tons for 360° working area.
3. Operating radius is the horizontal distance from center of rotation to a vertical line through the center of gravity of the load.
4. Weight of hook block(s), slings and other load handling accessories is included in rated load. Their total weight must be subtracted from rated load to obtain weight that can be lifted.
5. Ratings shown are based on freely suspended loads and make no allowance for such factors as wind effect on lifted load, ground conditions out-of-level, operating speeds or any other condition that could be detrimental to the safe operation of this equipment. Operator, therefore, has the responsibility to judge the existing conditions and reduce lifted loads and operating speeds accordingly.
6. Ratings are for operation on a firm and level surface.
7. At radii and boom lengths where no ratings are shown on chart, operation is not intended nor approved.
8. Boom inserts and guy lines must be arranged as shown in the "Operator's Manual".
9. Gantry must be in raised position for all conditions.
10. Boom backstops are required for all boom lengths.
11. Ratings shown in are determined by the strength of the boom or other structural component.
12. Instruction in the "Operator's Manual" must be strictly observed when operating the machine.
13. Long boom ratings: Deduct weight of hook block, slings, and all other load handling accessories from long boom ratings shown.
14. Auxiliary sheave ratings: Deduct weight of ball hook, slings, and all other load handling accessories from auxiliary sheave ratings for long boom shown.
15. Long boom lengths for auxiliary sheave mounting are 61.0 m to 76.2 m.

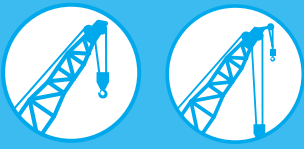

Long Boom Lifting Capacity

Unit: metric ton

Counterweight: 52.3 t

Working radius (m)	Boom Length (m)							Working radius (m)
	61.0	64.0	67.1	70.1	73.2	76.2	79.2	
12.0	12.3m/24.0	12.8m/24.0	13.3m/24.0	13.9m/24.0				12.0
14.0	24.0	24.0	24.0	24.0	14.4m/22.1	14.9m/18.7	15.4m/16.3	14.0
16.0	24.0	24.0	24.0	24.0	20.9	17.9	15.9	16.0
18.0	22.8	22.6	22.5	22.5	19.5	16.7	14.8	18.0
20.0	19.7	19.5	19.5	19.4	18.3	15.7	13.9	20.0
22.0	17.3	17.1	17.0	17.0	16.9	14.8	13.1	22.0
24.0	15.3	15.1	15.0	15.0	14.9	14.0	12.3	24.0
26.0	13.7	13.5	13.4	13.4	13.3	13.1	11.7	26.0
28.0	12.3	12.1	12.0	12.0	11.9	11.7	11.2	28.0
30.0	11.1	10.9	10.8	10.8	10.7	10.6	10.5	30.0
32.0	10.1	9.9	9.8	9.8	9.7	9.5	9.5	32.0
34.0	9.2	9.0	8.9	8.9	8.8	8.7	8.6	34.0
36.0	8.4	8.3	8.2	8.1	8.0	7.9	7.8	36.0
38.0	7.8	7.6	7.5	7.5	7.4	7.2	7.2	38.0
40.0	7.2	7.0	6.9	6.8	6.7	6.6	6.5	40.0
42.0	6.6	6.4	6.3	6.3	6.2	6.0	6.0	42.0
44.0	6.1	5.9	5.8	5.8	5.7	5.5	5.5	44.0
46.0	5.7	5.5	5.4	5.3	5.2	5.1	5.0	46.0
48.0	5.3	5.1	5.0	4.9	4.8	4.7	4.6	48.0
50.0	4.9	4.7	4.6	4.6	4.5	4.3	4.3	50.0
52.0	4.6	4.4	4.3	4.2	4.1	4.0	3.9	52.0
54.0	4.3	4.1	3.9	3.9	3.8	3.6	3.5	54.0
56.0	54.4m/4.2	3.8	3.7	3.6	3.5	3.3	3.2	56.0
58.0		57.0m/3.6	3.4	3.3	3.2	2.9	2.9	58.0
60.0			59.7m/3.1	3.0	2.9	2.6	2.6	60.0
62.0				2.8	2.6	2.4	2.3	62.0
64.0				62.3m/2.7	2.4	2.1	2.0	64.0
66.0					64.9m/2.2			66.0
Reeves	2	2	2	2	2	2	2	Reeves

Note:

Ratings according to Japanese Construction Codes for Mobile Cranes and Japanese Safety Ordinance on Cranes, etc.

Ratings shown in are determined by the strength of the boom or other structural components.

Refer to notes P14.

Auxiliary Sheave Lifting Capacity for Long Boom (Without Main Hook)

Unit: metric ton

Counterweight: 52.3 t

Working radius (m)	Boom Length (m)							Working radius (m)
	61.0	64.0	67.1	70.1	73.2	76.2		
12.0	12.9m/12.0	13.4m/12.0						12.0
14.0	12.0	12.0	12.0	14.5m/12.0	15.0m/12.0	15.5m/12.0		14.0
16.0	12.0	12.0	12.0	12.0	12.0	12.0		16.0
18.0	12.0	12.0	12.0	12.0	12.0	12.0		18.0
20.0	12.0	12.0	12.0	12.0	12.0	12.0		20.0
22.0	12.0	12.0	12.0	12.0	12.0	12.0		22.0
24.0	12.0	12.0	12.0	12.0	12.0	12.0		24.0
26.0	12.0	12.0	12.0	12.0	12.0	12.0		26.0
28.0	12.0	11.8	11.7	11.7	11.6	11.4		28.0
30.0	10.8	10.6	10.5	10.5	10.4	10.3		30.0
32.0	9.8	9.6	9.5	9.5	9.4	9.2		32.0
34.0	8.9	8.7	8.6	8.6	8.5	8.4		34.0
36.0	8.1	8.0	7.9	7.8	7.7	7.6		36.0
38.0	7.5	7.3	7.2	7.2	7.1	6.9		38.0
40.0	6.9	6.7	6.6	6.5	6.4	6.3		40.0
42.0	6.3	6.1	6.0	6.0	5.9	5.7		42.0
44.0	5.8	5.6	5.5	5.5	5.4	5.2		44.0
46.0	5.4	5.2	5.1	5.0	4.9	4.8		46.0
48.0	5.0	4.8	4.7	4.6	4.5	4.4		48.0
50.0	4.6	4.4	4.3	4.3	4.2	4.0		50.0
52.0	4.3	4.1	4.0	3.9	3.8	3.7		52.0
54.0	4.0	3.8	3.6	3.6	3.5	3.3		54.0
56.0	55.1m/3.7	3.5	3.4	3.3	3.2	3.0		56.0
58.0		57.8m/3.2	3.1	3.0	2.9	2.6		58.0
60.0			2.8	2.7	2.6	2.3		60.0
62.0			60.4m/2.7	2.5	2.3	2.1		62.0
64.0				63.0m/2.4	2.1			64.0
66.0								66.0
Reeves	2	2	2	2	2	2		Reeves

Note:

Ratings according to Japanese Construction Codes for Mobile Cranes and Japanese Safety Ordinance on Cranes, etc.

Ratings shown in are determined by the strength of the boom or other structural components. Refer to notes P14.

Fixed Jib Working Ranges

Jib Offset Angle: 10°, 30°

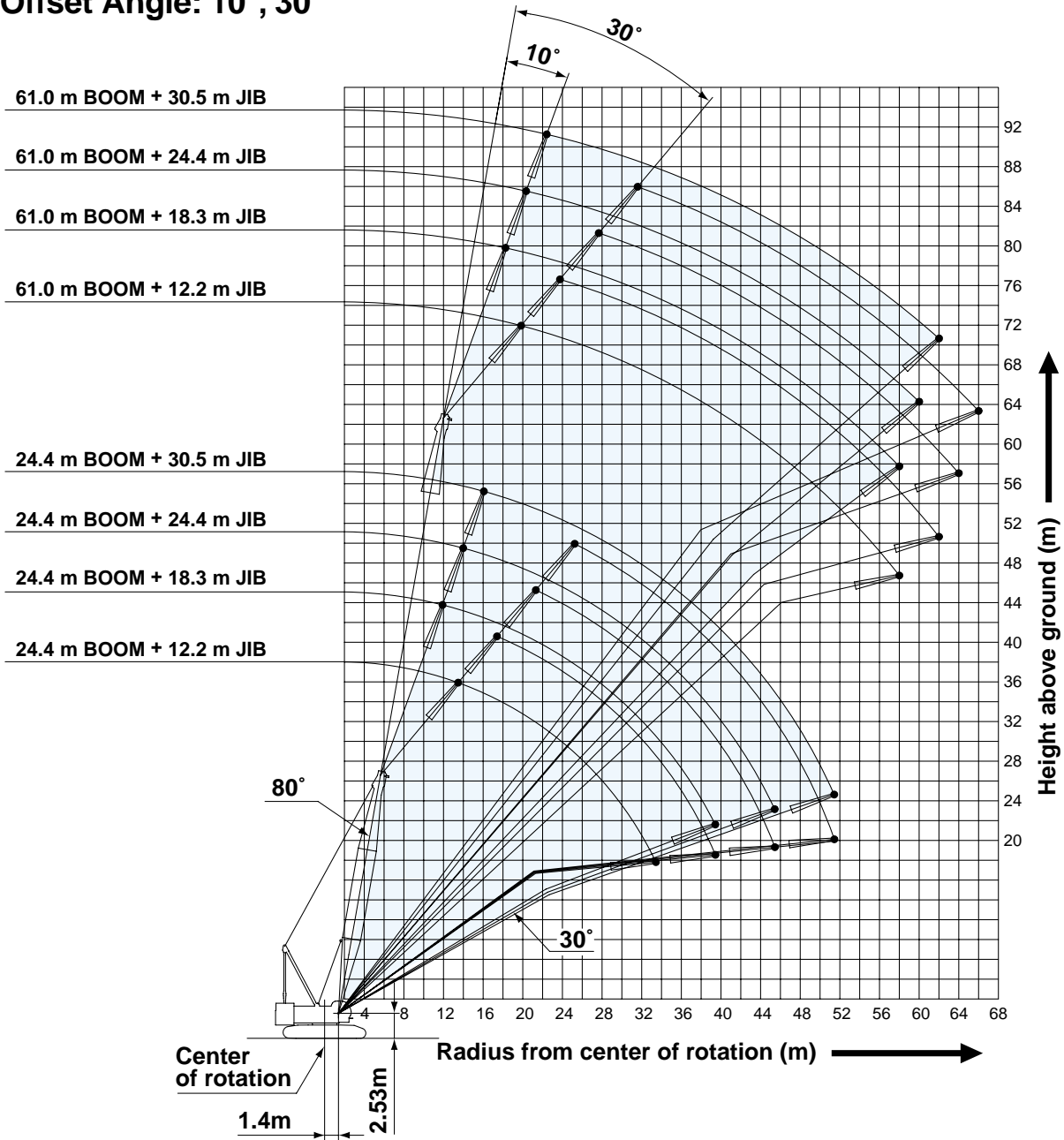

NOTES:

1. Ratings according to Japanese Construction Codes for Mobile Cranes and Japanese Safety Ordinance on Cranes, etc.
2. Ratings in metric tons for 360° working area.
3. Operating radius is the horizontal distance from center of rotation to a vertical line through the center of gravity of the load.
4. Weight of hook block(s), slings and other load handling accessories is included in rated load. Their total weight must be subtracted from rated load to obtain weight that can be lifted.
5. Ratings shown are based on freely suspended loads and make no allowance for such factors as wind effect on lifted load, ground conditions out-of-level, operating speeds or any other condition that could be detrimental to the safe operation of this equipment. Operator, therefore, has the responsibility to judge the existing conditions and reduce lifted loads and operating speeds accordingly.
6. Ratings are for operation on a firm and level surface.
7. At radii and boom lengths where no ratings are shown on chart, operation is not intended nor approved.
8. Boom/jib inserts and guy lines must be arranged as shown in the "Operator's Manual".
9. Gantry must be in raised position for all conditions.
10. Boom backstops are required for all boom lengths.
11. Ratings shown in are determined by the strength of the boom or other structural component.
12. Instruction in the "Operator's Manual" must be strictly observed when operating the machine.
13. Fixed jib ratings: Deduct weight of jib hook block, slings, and all other load handling accessories from jib ratings shown.
14. Crane boom lengths for fixed jib mounting are 24.4 m to 61.0 m.
15. The jib length of 12.2 m is based on the only setting of 30 degrees offset.



Fixed Jib Lifting Capacities (Without Main Hook)

Jib Offset Angle: 10°

Unit: metric ton

Counterweight: 52.3 t

Boom length (m)		24.4			30.5			36.6			42.7			Boom length (m)	
Jib length (m)		18.3	24.4	30.5	18.3	24.4	30.5	18.3	24.4	30.5	18.3	24.4	30.5	Jib length (m)	
Working radius (m)	12.0	12.2 m/12.0			13.3 m/12.0										12.0
	14.0	12.0	14.3 m/8.0		12.0	15.4 m/8.0		14.4 m/12.0			15.4 m/12.0				14.0
	16.0	12.0	8.0	16.4 m/4.0	12.0	8.0	17.5 m/4.0	12.0	16.4 m/8.0		12.0	17.5 m/8.0			16.0
	18.0	12.0	8.0	4.0	12.0	8.0	4.0	12.0	8.0	18.5 m/4.0	12.0	8.0	19.6 m/4.0		18.0
	20.0	12.0	8.0	4.0	12.0	8.0	4.0	12.0	8.0	4.0	12.0	8.0	4.0		20.0
	22.0	12.0	7.6	4.0	12.0	8.0	4.0	12.0	8.0	4.0	12.0	8.0	4.0		22.0
	24.0	12.0	7.3	4.0	12.0	7.6	4.0	12.0	7.9	4.0	12.0	8.0	4.0		24.0
	26.0	12.0	7.0	4.0	12.0	7.3	4.0	12.0	7.6	4.0	12.0	7.9	4.0		26.0
	28.0	11.8	6.7	3.9	12.0	7.0	4.0	12.0	7.3	4.0	12.0	7.6	4.0		28.0
	30.0	11.0	6.4	3.7	11.9	6.8	3.9	11.5	7.1	4.0	11.2	7.4	4.0		30.0
	34.0	9.7	6.0	3.4	10.0	6.3	3.6	9.6	6.6	3.8	9.3	6.9	4.0		34.0
	38.0	8.7	5.6	3.1	8.5	5.9	3.3	8.1	6.2	3.5	7.8	6.5	3.7		38.0
	42.0	40.0 m/8.3	5.3	2.9	7.3	5.6	3.1	6.9	5.9	3.3	6.6	6.2	3.4		42.0
	46.0		44.0 m/5.2	2.7	44.0 m/6.9	5.4	2.9	6.0	5.6	3.1	5.7	5.9	3.2		46.0
	50.0			2.6		5.2	2.7	5.2	5.4	2.9	4.9	5.1	3.0		50.0
	54.0					2.6	2.6	4.7	2.7	4.2	4.4	2.9	2.9		54.0
	58.0						56.0 m/2.5		56.0 m/4.5	2.6	56.0 m/3.9	3.9	2.7		58.0
	62.0									60.0 m/2.5		60.0 m/3.6	2.6		62.0
66.0												2.5		66.0	
Reeves	1	1	1	1	1	1	1	1	1	1	1	1	1	Reeves	

Boom length (m)		48.8			54.9			61.0			Boom length (m)	
Jib length (m)		18.3	24.4	30.5	18.3	24.4	30.5	18.3	24.4	30.5	Jib length (m)	
Working radius (m)	16.0	16.5 m/12.0			17.5 m/12.0							16.0
	18.0	12.0	18.6 m/8.0		12.0	19.6 m/8.0		18.6 m/12.0				18.0
	20.0	12.0	8.0	20.6 m/4.0	12.0	8.0	21.7 m/4.0	12.0	20.7 m/8.0			20.0
	22.0	12.0	8.0	4.0	12.0	8.0	4.0	12.0	8.0	22.8 m/4.0		22.0
	24.0	12.0	8.0	4.0	12.0	8.0	4.0	12.0	8.0	4.0		24.0
	26.0	12.0	8.0	4.0	12.0	8.0	4.0	12.0	8.0	4.0		26.0
	28.0	12.0	7.9	4.0	11.7	8.0	4.0	11.4	8.0	4.0		28.0
	30.0	10.9	7.6	4.0	10.5	7.9	4.0	10.2	8.0	4.0		30.0
	34.0	8.9	7.2	4.0	8.6	7.4	4.0	8.2	7.6	4.0		34.0
	38.0	7.4	6.8	3.8	7.1	7.0	4.0	6.7	7.1	4.0		38.0
	42.0	6.2	6.4	3.6	5.9	6.2	3.7	5.5	5.9	3.9		42.0
	46.0	5.3	5.6	3.4	4.9	5.2	3.5	4.5	4.9	3.7		46.0
	50.0	4.5	4.8	3.2	4.1	4.4	3.3	3.6	4.1	3.5		50.0
	54.0	3.8	4.1	3.0	3.3	3.7	3.2	2.8	3.2	3.3		54.0
	58.0	3.2	3.5	2.9	2.6	3.0	3.0	2.1	2.5	2.7		58.0
	62.0	60.0 m/2.9	2.9	2.7	2.1	2.4	2.5		60.0 m/2.2	2.1		62.0
	66.0		2.4	2.5		64.0 m/2.1	2.0					66.0
	70.0			2.1								70.0
Reeves	1	1	1	1	1	1	1	1	1	1	Reeves	

Note:

Ratings according to Japanese Construction Codes for Mobile Cranes and Japanese Safety Ordinance on Cranes, etc.

Ratings shown in are determined by the strength of the boom or other structural components.

Refer to notes P16.

The jib length of 12.2 m is based on the only setting of 30 degrees offset.

HYDRAULIC CRAWLER CRANE 7120

Unit: metric ton

Jib Offset Angle: 30°

Counterweight: 52.3 t

Boom length (m)		24.4				30.5				36.6				42.7				Boom length (m)	
Jib length (m)		12.2	18.3	24.4	30.5	12.2	18.3	24.4	30.5	12.2	18.3	24.4	30.5	12.2	18.3	24.4	30.5	Jib length (m)	
Working radius (m)	12.0	13.8 m/10.0																	12.0
	14.0	10.0				14.9 m/10.0				15.9 m/10.0									14.0
	16.0	10.0	17.7 m/9.0			10.0				10.0				17.0 m/10.0					16.0
	18.0	10.0	9.0			10.0	18.8 m/9.0			10.0	19.9 m/9.0			10.0					18.0
	20.0	10.0	9.0	21.7 m/6.0		10.0	9.0			10.0	9.0			10.0	20.9 m/9.0				20.0
	22.0	10.0	9.0	6.0		10.0	9.0	22.7 m/6.0		10.0	9.0	23.8 m/6.0		10.0	9.0				22.0
	24.0	10.0	9.0	6.0	25.6 m/3.0	10.0	9.0	6.0		10.0	9.0	6.0		10.0	9.0	24.8 m/6.0			24.0
	26.0	10.0	9.0	6.0	3.0	10.0	9.0	6.0	26.6 m/3.0	10.0	9.0	6.0	27.7 m/3.0	10.0	9.0	6.0			26.0
	28.0	10.0	8.7	5.8	3.0	10.0	9.0	6.0	3.0	10.0	9.0	6.0	3.0	10.0	9.0	6.0	28.8 m/3.0		28.0
	30.0	10.0	8.3	5.7	3.0	10.0	8.9	5.8	3.0	10.0	9.0	6.0	3.0	10.0	9.0	6.0	3.0		30.0
	34.0	10.0	7.6	5.4	2.9	9.9	8.1	5.6	3.0	9.6	8.6	5.7	3.0	9.3	9.0	5.8	3.0		34.0
	38.0		7.1	5.2	2.7	8.4	7.5	5.4	2.8	8.1	8.0	5.5	2.9	7.8	8.3	5.6	3.0		38.0
	42.0		40.0 m/6.9	5.0	2.6	40.0 m/7.8	7.1	5.2	2.7	6.9	7.3	5.3	2.8	6.6	7.0	5.4	2.8		42.0
	46.0			4.7	2.5		6.5	5.0	2.6	44.0 m/6.3	6.2	5.2	2.7	5.6	6.0	5.3	2.7		46.0
	50.0				2.4			4.8	2.5		5.4	5.0	2.6	4.8	5.1	5.1	2.6		50.0
	54.0				52.0 m/2.4			52.0 m/4.7	2.4		52.0 m/5.0	4.8	2.5		4.4	4.6	2.5		54.0
	58.0								2.4			56.0 m/4.6	2.4		56.0 m/4.1	4.0	2.5		58.0
	62.0												2.4			3.5	2.4		62.0
	66.0																2.4		66.0
	Reeves	1	1	1	1	1	1	1	1	1	1	1	1	1	1	1	1	1	Reeves

Boom length (m)		48.8				54.9				61.0				Boom length (m)	
Jib length (m)		12.2	18.3	24.4	30.5	12.2	18.3	24.4	30.5	12.2	18.3	24.4	30.5	Jib length (m)	
Working radius (m)	18.0	18.1m/10.0				19.1 m/10.0									18.0
	20.0	10.0				10.0				20.1 m/10.0					20.0
	22.0	10.0	9.0			10.0	23.0 m/9.0			10.0					22.0
	24.0	10.0	9.0	25.9 m/6.0		10.0	9.0			10.0	24.1 m/9.0				24.0
	26.0	10.0	9.0	6.0		10.0	9.0	26.9 m/6.0		10.0	9.0				26.0
	28.0	10.0	9.0	6.0	29.8 m/3.0	10.0	9.0	6.0		10.0	9.0	6.0			28.0
	30.0	10.0	9.0	6.0	3.0	10.0	9.0	6.0	30.9 m/3.0	10.0	9.0	6.0	31.9 m/3.0		30.0
	34.0	9.0	9.0	5.9	3.0	8.7	9.0	6.0	3.0	8.4	9.0	6.0	3.0		34.0
	38.0	7.5	8.0	5.7	3.0	7.1	7.7	5.8	3.0	6.8	7.4	5.9	3.0		38.0
	42.0	6.2	6.7	5.5	2.9	5.9	6.4	5.6	3.0	5.6	6.1	5.7	3.0		42.0
	46.0	5.2	5.7	5.4	2.8	4.9	5.4	5.5	2.8	4.6	5.1	5.5	2.9		46.0
	50.0	4.4	4.8	5.1	2.7	4.1	4.5	4.8	2.7	3.6	4.2	4.6	2.8		50.0
	54.0	3.7	4.1	4.4	2.6	3.2	3.8	4.1	2.6	2.8	3.4	3.8	2.7		54.0
	58.0	56.0 m/3.4	3.5	3.7	2.5	2.5	3.0	3.4	2.6	2.0	2.6	3.0	2.6		58.0
	62.0		2.8	3.2	2.5	60.0 m/2.2	2.4	2.7	2.5		2.0	2.3	2.5		62.0
	66.0			2.6	2.4		64.0 m/2.1	2.1	2.4			64.0 m/2.0	2.0		66.0
	70.0			68.0 m/2.3	2.3				68.0 m/2.1						70.0
	72.0				2.1										72.0
	Reeves	1	1	1	1	1	1	1	1	1	1	1	1	1	Reeves

Note:

Ratings according to Japanese Construction Codes for Mobile Cranes and Japanese Safety Ordinance on Cranes, etc.

Ratings shown in are determined by the strength of the boom or other structural components.

Refer to notes P16.

The jib length of 12.2 m is based on the only setting of 30 degrees offset.

Tower Jib Working Ranges

Tower Length: 39.5m

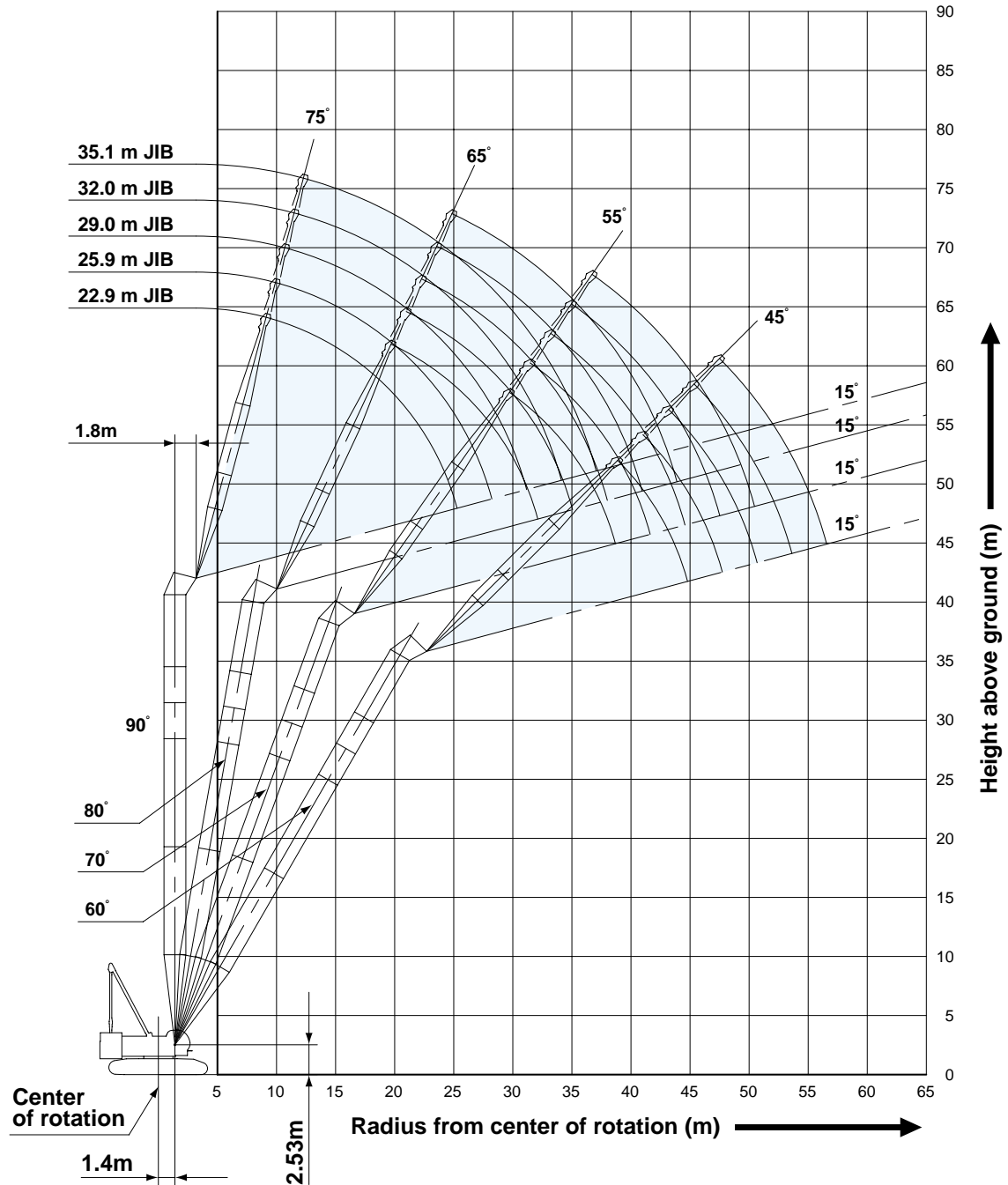

NOTES:

1. Ratings according to Japanese Construction Codes for Mobile Cranes and Japanese Safety Ordinance on Cranes, etc.
2. Ratings in metric tons for 360° working area.
3. Operating radius is the horizontal distance from center of rotation to a vertical line through the center of gravity of the load.
4. Weight of hook block(s), slings and other load handling accessories is included in rated load. Their total weight must be subtracted from rated load to obtain weight that can be lifted.
5. Ratings shown are based on freely suspended loads and make no allowance for such factors as wind effect on lifted load, ground condi-

- tions out-of-level, operating speeds or any other condition that could be detrimental to the safe operation of this equipment. Operator, therefore, has the responsibility to judge the existing conditions and reduce lifted loads and operating speeds accordingly.
6. Ratings are for operation on a firm and level surface.
7. At radii and boom lengths where no ratings are shown on chart, operation is not intended nor approved.
8. Tower/tower jib inserts and guy lines must be arranged as shown in the "Operator's Manual".
9. Tower jib hoist reeving is 8 part line.
10. Gantry must be in raised position for all conditions.

Tower Length: 51.7m

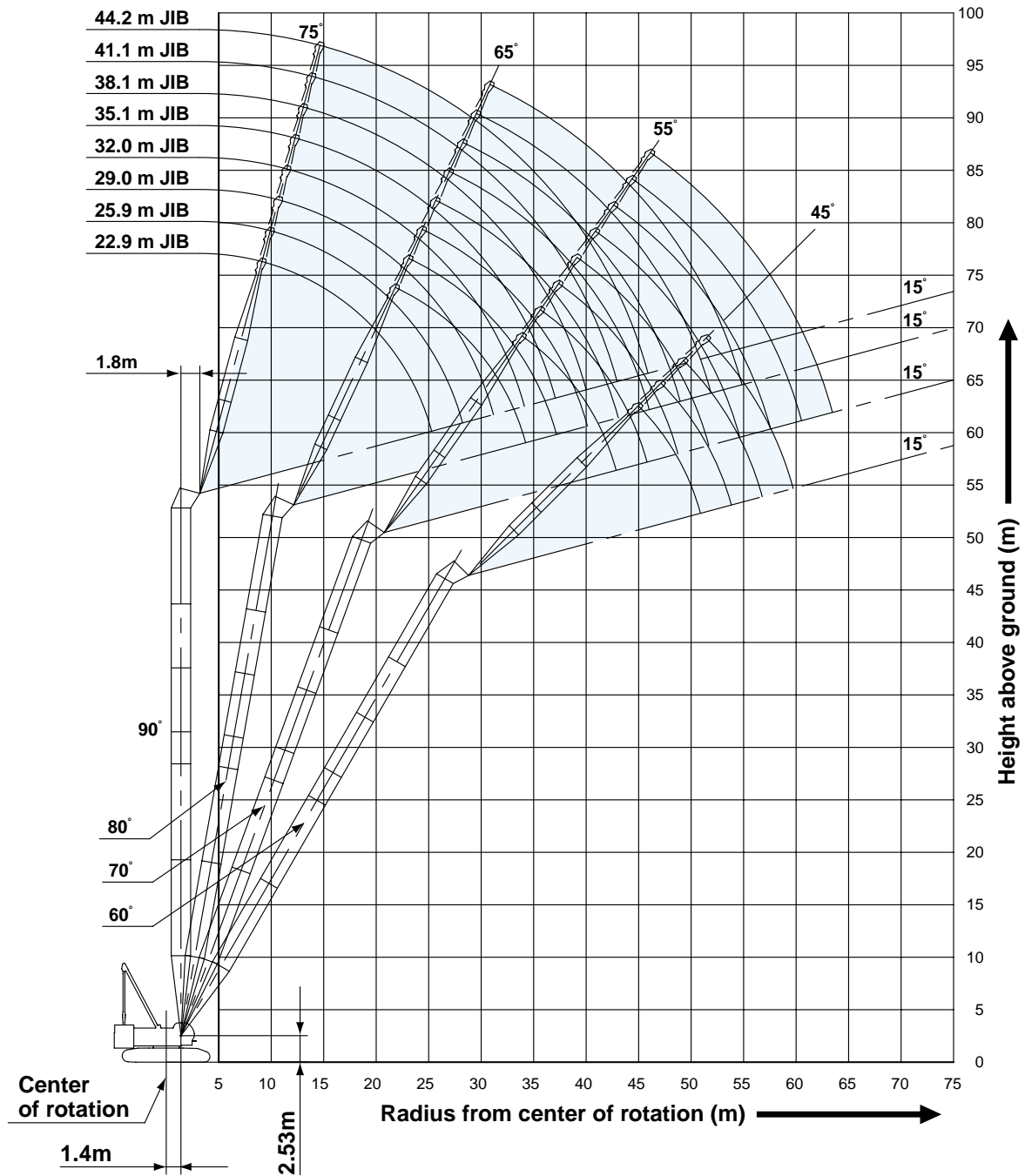

11. Tower and tower jib backstops are required for all tower and tower jib combinations.
12. Ratings shown in are determined by the strength of the tower or other structural component.
13. When erecting and lowering the tower length of 51.7 m, the pillow plate for erection must be placed at the end of crawlers.
14. Instruction in the "Operator's Manual" must be strictly observed when operating the machine.
15. Tower jib ratings: Deduct weight of hook block, slings, and all other load handling accessories from tower jib ratings shown.



Tower Jib Lifting Capacities

Unit: metric ton

Counterweight: 52.3 t

30.4 m Tower Length	Tower length (m)		30.4								Tower length (m)	
	Jib length (m)		22.9				25.9				Jib length (m)	
	Tower angle		90°	80°	70°	60°	90°	80°	70°	60°	Tower angle	
Working radius (m)	9.4	20.0										9.4
	10.0	20.0					10.2 m/20.0					10.0
	12.0	20.0					20.0					12.0
	14.0	20.0					20.0					14.0
	15.0	20.0					20.0					15.0
	16.0	18.7					18.7					16.0
	18.0	16.6	18.4 m/16.3				16.6	19.7 m/15.2				18.0
	20.0	15.0	15.0				15.0	15.0				20.0
	22.0	13.3	13.6				13.6	13.6				22.0
	24.0	9.9	12.5				12.1	12.5				24.0
	26.0	25.4 m/7.1	11.5	26.8 m/11.1			9.5	11.5				26.0
	28.0		10.7	10.7			6.7	10.7	28.6 m/10.4			28.0
	30.0		10.0	10.0			28.3 m/6.1	10.0	10.0			30.0
	32.0		30.6 m/9.4	9.3				9.3	9.3			32.0
	34.0			8.8	34.5 m/8.5			33.5 m/7.7	8.8			34.0
	36.0			35.6 m/8.4	7.9				8.3	36.7 m/7.7		36.0
	38.0				7.5				7.8	7.3		38.0
	40.0				7.0				38.6 m/7.7	6.9		40.0
	42.0				40.3 m/6.9					6.4		42.0
	44.0									43.2 m/6.2		44.0
Reeves	2	2	2	2	2	2	2	2	2	2	Reeves	

33.4 m Tower Length	Tower length (m)		33.4								29.0				Tower length (m)	
	Jib length (m)		22.9				25.9				29.0				Jib length (m)	
	Tower angle		90°	80°	70°	60°	90°	80°	70°	60°	90°	80°	70°	60°	Tower angle	
Working radius (m)	9.4	20.0													9.4	
	10.0	20.0					10.2 m/20.0						11.0 m/20.0		10.0	
	12.0	20.0					20.0						20.0		12.0	
	14.0	20.0					20.0						20.0		14.0	
	15.0	20.0					20.0						20.0		15.0	
	16.0	18.7					18.7						18.7		16.0	
	18.0	16.6	18.9 m/15.8				16.6						16.6		18.0	
	20.0	15.0	15.0				15.0	20.2 m/14.8					15.0	21.5 m/13.9	20.0	
	22.0	13.4	13.6				13.6	13.6					13.6	13.6	22.0	
	24.0	10.0	12.5				12.3	12.5					12.5	12.5	24.0	
	26.0	25.4 m/7.2	11.5	27.9 m/10.7			9.7	11.5					11.2	11.5	26.0	
	28.0		10.7	10.7			6.9	10.7	29.6 m/10.1				9.1	10.7	28.0	
	30.0		10.0	10.0			28.3 m/6.2	10.0	10.0				7.0	10.0	30.0	
	32.0		31.1 m/9.5	9.3				9.3	9.3				31.2 m/5.3	9.3	32.0	
	34.0			8.8				8.6	8.8				8.8	8.8	34.0	
	36.0			8.3	7.6			34.1 m/8.1	8.3				8.3	8.3	36.0	
	38.0			36.7 m/8.1	7.0				7.8	38.2 m/6.9			37.0 m/7.0	7.8	38.0	
	40.0				6.6				39.6 m/7.5	6.4				7.4	40.3 m/6.3	40.0
	42.0				41.8 m/6.2					6.1				6.9	5.8	42.0
	44.0									5.7				42.6 m/6.8	5.6	44.0
46.0									44.8 m/5.6					5.2	46.0	
48.0														47.7 m/5.0	48.0	
Reeves	2	2	2	2	2	2	2	2	2	2	2	2	2	2	Reeves	

Note:

Ratings according to Japanese Construction Codes for Mobile Cranes and Japanese Safety Ordinance on Cranes, etc.

Ratings shown in are determined by the strength of the tower or other structural components.

Refer to notes P19 and P20.

HYDRAULIC CRAWLER CRANE

7120

Unit: metric ton

Counterweight: 52.3 t

36.5 m Tower Length	36.5																	Working radius (m)
	22.9				25.9				29.0				32.0				Tower length (m)	
	Jib length (m)				Jib length (m)				Jib length (m)				Jib length (m)				Jib length (m)	
Tower angle	90°	80°	70°	60°	90°	80°	70°	60°	90°	80°	70°	60°	90°	80°	70°	60°	Tower angle	
9.4	20.0																9.4	
10.0	20.0				10.2 m/20.0				11.0 m/20.0				11.8 m/20.0				10.0	
12.0	20.0				20.0				20.0				20.0				12.0	
14.0	20.0				20.0				20.0				19.6				14.0	
15.0	20.0				20.0				20.0				19.1				15.0	
16.0	18.7				18.7				18.7				18.6				16.0	
18.0	16.6	19.4 m/15.4			16.6				16.6				16.6				18.0	
20.0	15.0	15.0			15.0	20.7 m/14.4			15.0				15.0				20.0	
22.0	13.5	13.6			13.6	13.6			13.6	13.6			13.6	23.3 m/12.8			22.0	
24.0	10.1	12.5			12.4	12.5			12.5	12.5			12.5	12.5			24.0	
26.0	25.4 m/7.3	11.5			9.8	11.5			11.2	11.5			11.5	11.5			26.0	
28.0		10.7	28.9 m/10.3		6.9	10.7			9.2	10.7			10.2	10.7			28.0	
30.0		10.0	10.0		28.3 m/6.3	10.0	30.7 m/9.7		7.1	10.0			8.6	10.0			30.0	
32.0		31.7 m/9.4	9.3			9.3	9.3		31.2 m/5.4	9.3	32.4 m/9.2		6.9	9.3			32.0	
34.0			8.8			8.8	8.8			8.8	8.7		5.0	8.8	34.2 m/8.6		34.0	
36.0			8.3	37.6 m/6.8		34.6 m/8.2	8.3			8.3	8.2		34.2 m/4.6	8.3	8.0		36.0	
38.0			37.7 m/7.9	6.6			7.8	39.7 m/6.2		37.6 m/7.1	7.7			7.8	7.6		38.0	
40.0				6.2			7.2	6.0			7.2	41.9 m/5.6		7.0	7.1		40.0	
42.0				5.8			40.7 m/7.1	5.7			6.7	5.5	40.5 m/6.2		6.6		42.0	
44.0				43.3 m/5.6				5.4			43.6 m/6.3	5.2			6.2	5.0	44.0	
46.0								5.0				4.9			5.9	4.7	46.0	
48.0								46.3 m/5.0				4.6		46.5 m/5.7	4.6		48.0	
50.0												49.2 m/4.4				4.3	50.0	
52.0																4.0	52.0	
54.0																52.2 m/3.8	54.0	
Reeves	2	2	2	2	2	2	2	2	2	2	2	2	2	2	2	2	Reeves	

39.5 m Tower Length	39.5																	Working radius (m)				
	22.9				25.9				29.0				32.0				35.1				Tower length (m)	
	Jib length (m)				Jib length (m)				Jib length (m)				Jib length (m)				Jib length (m)				Jib length (m)	
Tower angle	90°	80°	70°	60°	90°	80°	70°	60°	90°	80°	70°	60°	90°	80°	70°	60°	90°	80°	70°	60°	Tower angle	
9.4	20.0																				9.4	
10.0	20.0				10.2 m/20.0				11.0 m/20.0				11.8 m/20.0								10.0	
12.0	20.0				20.0				20.0				20.0				12.5 m/16.5				12.0	
14.0	20.0				20.0				20.0				19.6				16.3				14.0	
15.0	20.0				20.0				20.0				19.1				16.0				15.0	
16.0	18.7				18.7				18.7				18.6				15.7				16.0	
18.0	16.6				16.6				16.6				16.6				15.3				18.0	
20.0	15.0	15.0			15.0	21.2 m/14.1			15.0				15.0			14.9					20.0	
22.0	13.6	13.6			13.6	13.6			13.6	22.5 m/13.3			13.6	23.8 m/12.6			13.6				22.0	
24.0	10.2	12.5			12.4	12.5			12.5	12.5			12.5	12.5			12.5	26.1 m/11.9			24.0	
26.0	25.4 m/7.4	11.5			9.8	11.5			11.3	11.5			11.5	11.5			11.5	11.5			26.0	
28.0		10.7			7.0	10.7			9.3	10.7			10.2	10.7			10.7	10.7			28.0	
30.0		10.0	10.0		28.3 m/6.3	10.0	31.7 m/9.4		7.2	10.0			8.6	10.0			9.4	10.0			30.0	
32.0		9.3	9.3			9.3	9.2		31.2 m/5.4	9.3	33.5 m/8.6		6.9	9.3			8.0	9.3			32.0	
34.0		32.2 m/9.3	8.7			8.8	8.6			8.8	8.4		5.0	8.8	35.2 m/8.0		6.7	8.8			34.0	
36.0			8.1			35.1 m/8.2	8.0			8.3	7.9		34.2 m/4.7	8.3	7.7		5.2	8.3	36.9 m/7.4		36.0	
38.0			7.5	39.1 m/6.0			7.5			7.5	7.3			7.8	7.2		37.1 m/4.1	7.8	7.0		38.0	
40.0			38.8 m/7.3	5.7			7.0	41.2 m/5.3		38.1 m/7.1	6.9			7.4	6.8			7.5	6.7		40.0	
42.0				5.4			41.7 m/6.5	5.2		6.4	43.4 m/4.7		6.0	4.7	41.0 m/6.2	6.3			7.1	6.3	42.0	
44.0				5.1				5.0		6.0	4.7			6.0	4.5 m/4.3			5.4	5.9		44.0	
46.0				44.9 m/4.8				4.7		44.6 m/5.9	4.5			5.6	4.3				5.5	4.7 m/4.0	46.0	
48.0								47.8 m/4.4			4.3			47.6 m/5.3	4.2				5.2	4.0	48.0	
50.0											4.0				3.9				4.9	3.8	50.0	
52.0											50.8 m/3.9				3.7				50.5 m/4.8	3.6	52.0	
54.0															53.7 m/3.5					3.4	54.0	
56.0																				3.2	56.0	
58.0																				56.6 m/3.1	58.0	
Reeves	2	2	2	2	2	2	2	2	2	2	2	2	2	2	2	2	2	2	2	2	Reeves	

Note:
 Ratings according to Japanese Construction Codes for Mobile Cranes and Japanese Safety Ordinance on Cranes, etc.
 Ratings shown in [] are determined by the strength of the tower or other structural components.
 Refer to notes P19 and P20.

Unit: metric ton

Counterweight: 52.3 t

42.5 m Tower Length	42.5													Tower length (m)
	22.9				25.9				29.0				Jib length (m)	
	Tower angle	90°	80°	70°	60°	90°	80°	70°	60°	90°	80°	70°	60°	Tower angle
9.4	20.0													9.4
10.0	20.0					10.2 m/20.0				11.0 m/20.0				10.0
12.0	20.0					20.0				20.0				12.0
14.0	20.0					20.0				20.0				14.0
15.0	20.0					20.0				20.0				15.0
16.0	18.7					18.7				18.7				16.0
18.0	16.6					16.6				16.6				18.0
20.0	15.0	20.5 m/14.6				15.0	21.8 m/13.7			15.0				20.0
22.0	13.6	13.6				13.6	13.6			13.6	23.1 m/12.9			22.0
24.0	10.3	12.5				12.5	12.5			12.5	12.5			24.0
26.0	25.4 m/7.5	11.5				9.9	11.5			11.3	11.5			26.0
28.0		10.7				7.1	10.7			9.3	10.7			28.0
30.0		10.0	31.0 m/9.5			28.3 m/6.4	10.0			7.2	10.0			30.0
32.0		9.3	9.0				9.3	32.7 m/8.7		31.2 m/5.5	9.3			32.0
34.0		32.7 m/9.1	8.4				8.8	8.2		8.8	34.5 m/8.0			34.0
36.0			7.8				35.7 m/8.2	7.7		8.3	7.5			36.0
38.0			7.3					7.2		7.8	7.1			38.0
40.0			39.8 m/6.8	40.6 m/5.2				6.7		38.6 m/7.1	6.6			40.0
42.0				5.0				6.3	42.8 m/4.6		6.2			42.0
44.0				4.7				42.7 m/6.1	4.5		5.8	44.9 m/4.2		44.0
46.0				4.4					4.3		45.7 m/5.4	4.1		46.0
48.0				46.4 m/4.3					4.1			3.9		48.0
50.0									49.3 m/3.9			3.7		50.0
52.0												3.5		52.0
54.0												52.3 m/3.4		54.0
Reeves	2	2	2	2	2	2	2	2	2	2	2	2	2	Reeves

42.5 m Tower Length	42.5													Tower length (m)
	32.0				35.1				38.1				Jib length (m)	
	Tower angle	90°	80°	70°	60°	90°	80°	70°	60°	90°	80°	70°	60°	Tower angle
10.0	11.8 m/20.0													10.0
12.0	20.0					12.5 m/16.5				13.3 m/13.6				12.0
14.0	19.5					16.2				13.6				14.0
15.0	19.0					16.0				13.4				15.0
16.0	18.5					15.7				13.1				16.0
18.0	16.6					15.3				12.7				18.0
20.0	15.0					14.8				12.3				20.0
22.0	13.6					13.6				11.9				22.0
24.0	12.5	24.4 m/12.2				12.5	25.6 m/11.7			11.6				24.0
26.0	11.5	11.5				11.5	11.5			11.2	26.9 m/11.1			26.0
28.0	10.3	10.7				10.7	10.7			10.5	10.7			28.0
30.0	8.7	10.0				9.4	10.0			9.6	10.0			30.0
32.0	7.0	9.3				8.0	9.3			8.5	9.3			32.0
34.0	5.1	8.8				6.7	8.8			7.4	8.8			34.0
36.0	34.2 m/4.7	8.3	36.2 m/7.4			5.3	8.3			6.3	8.3			36.0
38.0		7.8	6.8			37.1 m/4.1	7.8	6.8		5.1	7.8	39.7 m/6.3		38.0
40.0		7.5	6.5				7.5	6.4		3.7	7.5	6.1		40.0
42.0		41.5 m/6.2	6.1				7.1	6.0		40.1 m/3.5	7.1	5.9		42.0
44.0			5.7				6.1	5.6		6.7	5.5			44.0
46.0			5.4	47.1 m/3.8		44.5 m/5.4	5.3			5.9	5.2			46.0
48.0			5.0	3.7				5.0	49.2 m/3.4	47.4 m/4.7	4.9			48.0
50.0			48.6 m/4.9	3.6				4.7	3.4		4.6	51.4 m/3.2		50.0
52.0				3.4				51.6 m/4.4	3.3		4.3	3.1		52.0
54.0				3.2					3.1		4.1	3.0		54.0
56.0					55.2 m/3.0				2.9		54.5 m/3.8	2.8		56.0
58.0									2.8			2.6		58.0
60.0									58.2 m/2.7			2.5		60.0
62.0												61.1 m/2.4		62.0
Reeves	2	2	2	2	2	2	2	2	2	2	2	2	2	Reeves

Note:

Ratings according to Japanese Construction Codes for Mobile Cranes and Japanese Safety Ordinance on Cranes, etc.

Ratings shown in are determined by the strength of the tower or other structural components.

Refer to notes P19 and P20.

HYDRAULIC CRAWLER CRANE

7120

Unit: metric ton

Counterweight: 52.3 t

45.6 m Tower Length	45.6																	Tower length (m)	
	22.9				25.9				29.0				32.0				Jib length (m)		
	Tower angle	90°	80°	70°	60°	90°	80°	70°	60°	90°	80°	70°	60°	90°	80°	70°	60°	Tower angle	
Working radius (m)	9.4	20.0																9.4	
	10.0	20.0				10.2 m/20.0				11.0 m/20.0				11.8m/20.0				10.0	
	12.0	20.0				20.0				20.0				20.0				12.0	
	14.0	20.0				20.0				20.0				19.5				14.0	
	15.0	20.0				20.0				20.0				19.0				15.0	
	16.0	18.7				18.7				18.7				18.5				16.0	
	18.0	16.6				16.6				16.6				16.6				18.0	
	20.0	15.0	21.0 m/14.2			15.0				15.0				15.0				20.0	
	22.0	13.6	13.6			13.6	22.3 m/13.4			13.6	23.6 m/12.7			13.6				22.0	
	24.0	10.3	12.5			12.5	12.5			12.5	12.5			12.5	24.9 m/12.0			24.0	
	26.0	25.4 m/7.5	11.5			9.9	11.5			11.3	11.5			11.5	11.5			26.0	
	28.0		10.7			7.1	10.7			9.3	10.7			10.3	10.7			28.0	
	30.0		10.0			28.3 m/6.4	10.0			7.2	10.0			8.7	10.0			30.0	
	32.0		9.3	8.7			9.3	33.8 m/8.0		31.2 m/5.5	9.3			7.0	9.3			32.0	
	34.0		33.2 m/9.0	8.0			8.8	7.8			8.8	35.5m/7.4		5.2	8.8			34.0	
	36.0			7.5			8.3	7.4			8.3	7.1		34.2m/4.8	8.3	37.3 m/6.8		36.0	
	38.0			7.0			36.2 m/8.2	6.9			7.8	6.8			7.8	6.5		38.0	
	40.0			6.5				6.4			39.1 m/7.1	6.3			7.5	6.2		40.0	
	42.0			40.8 m/6.3	42.1 m/4.4			6.0				5.9			6.5	5.8		42.0	
	44.0				4.3			43.8 m/5.6	44.3 m/4.0			5.5			42.1 m/6.2	5.5		44.0	
46.0				4.1				3.9			5.2	46.4 m/3.6			5.1		46.0		
48.0				47.9 m/3.9				3.7			46.7 m/5.0	3.5		4.8	48.6 m/3.3		48.0		
50.0								3.5				3.4		49.7 m/4.4	3.2		50.0		
52.0								50.9 m/3.4				3.2			3.1		52.0		
54.0												53.8 m/3.0			2.9		54.0		
56.0															2.7		56.0		
58.0															56.7 m/2.6		58.0		
Reeves	2	2	2	2	2	2	2	2	2	2	2	2	2	2	2	2	2	Reeves	

45.6 m Tower Length	45.6												Tower length (m)	
	35.1				38.1				41.1				Jib length (m)	
	Tower angle	90°	80°	70°	60°	90°	80°	70°	60°	90°	80°	70°	Tower angle	
Working radius (m)	12.0	12.5 m/16.5				13.3 m/13.6						12.0		
	14.0	16.2				13.6				14.1 m/10.7		14.0		
	15.0	16.0				13.3				10.7		15.0		
	16.0	15.7				13.1				10.5		16.0		
	18.0	15.2				12.7				10.2		18.0		
	20.0	14.8				12.3				9.8		20.0		
	22.0	13.6				11.9				9.5		22.0		
	24.0	12.5				11.6				9.2		24.0		
	26.0	11.5	26.2 m/11.4			11.1	27.5 m/10.9			8.9		26.0		
	28.0	10.7	10.7			10.5	10.7			8.6	28.7 m/9.8	28.0		
	30.0	9.4	10.0			9.6	10.0			8.3	9.6	30.0		
	32.0	8.1	9.3			8.5	9.3			7.8	9.3	32.0		
	34.0	6.7	8.8			7.4	8.8			7.3	8.8	34.0		
	36.0	5.3	8.3			6.3	8.3			6.8	8.3	36.0		
	38.0	37.1 m/4.1	7.8	39.0 m/6.3		5.1	7.8			6.2	7.8	38.0		
	40.0		7.5	6.0		3.8	7.5	40.8 m/5.7		5.2	7.5	40.0		
	42.0		7.1	5.7		40.1 m/3.5	7.1	5.4		4.1	7.1	42.5 m/5.4	42.0	
	44.0		6.8	5.4			6.7	5.2		43.0 m/3.2	6.6	5.0	44.0	
	46.0		45.0 m/5.4	5.1			6.2	4.9			6.2	4.8	46.0	
	48.0			4.8			4.7	4.6			5.8	4.5	48.0	
50.0			4.5	50.7 m/3.0			4.4			5.2	4.3	50.0		
52.0			4.2	2.9			4.1	52.9 m/2.7		50.9 m/4.3	4.0	52.0		
54.0			52.6 m/3.9	2.8			3.9	2.6			3.8	54.0		
56.0				2.7			55.6 m/3.4	2.5			3.5	56.0		
58.0				2.5				2.4			3.3	58.0		
60.0				59.7 m/2.3				2.2			58.5 m/3.1	60.0		
62.0								2.1				62.0		
64.0								62.6 m/2.0				64.0		
Reeves	2	2	2	2	2	2	2	2	2	2	2	Reeves		

Note:
 Ratings according to Japanese Construction Codes for Mobile Cranes and Japanese Safety Ordinance on Cranes, etc.
 Ratings shown in [] are determined by the strength of the tower or other structural components.
 Refer to notes P19 and P20.

Unit: metric ton

Counterweight: 52.3 t

48.6 m Tower Length	48.6																	
	Tower length (m)	48.6																Tower length (m)
	Jib length (m)	22.9				25.9				29.0				32.0				Jib length (m)
	Tower angle	90°	80°	70°	60°	90°	80°	70°	60°	90°	80°	70°	60°	90°	80°	70°	60°	Tower angle
9.4	20.0																	9.4
10.0	20.0				10.2 m/20.0					11.0 m/20.0				11.8 m/19.9				10.0
12.0	20.0				20.0					20.0				19.9				12.0
14.0	20.0				20.0					19.5				18.6				14.0
15.0	20.0				19.8					18.9				18.0				15.0
16.0	18.7				18.7					18.3				17.5				16.0
18.0	16.6				16.6					16.6				16.5				18.0
20.0	15.0	21.5 m/13.9			15.0					15.0				15.0				20.0
22.0	13.6	13.6			13.6	22.8 m/13.1				13.6				13.6				22.0
24.0	10.4	12.5			12.5	12.5				12.5	24.1 m/12.4			12.5	25.4 m/11.8			24.0
26.0	25.4 m/7.5	11.5			10.0	11.5				11.4	11.5			11.5	11.5			26.0
28.0		10.7			7.1	10.7				9.4	10.7			10.3	10.7			28.0
30.0		10.0			28.3 m/6.4	10.0				7.3	10.0			8.7	10.0			30.0
32.0		9.3	33.1 m/8.0			9.3				31.2 m/5.5	9.3			7.1	9.3			32.0
34.0		33.8 m/8.8	7.6			8.8	34.8 m/7.4			8.8				5.2	8.8			34.0
36.0			7.2			8.3	6.9			8.3	36.6 m/6.8			34.2 m/4.8	8.3			36.0
38.0			6.7			36.7 m/8.1	6.6			7.8	6.3			7.8	38.3 m/6.2			38.0
40.0			6.3				6.2			39.7 m/7.1	6.0			7.3	5.8			40.0
42.0			41.9 m/5.8	43.7 m/3.8			5.8				5.6			6.7	5.5			42.0
44.0				3.8			5.4	45.8 m/3.4			5.3			42.6 m/6.2	5.2			44.0
46.0				3.7			44.8 m/5.2	3.4			5.0				4.9			46.0
48.0				3.4				3.3			47.8 m/4.5	3.1			4.6			48.0
50.0				49.4 m/3.1				3.1				3.0			4.3	50.1 m/2.7		50.0
52.0								2.9				2.8			50.7 m/4.0	2.6		52.0
54.0								52.4 m/2.8				2.6				2.5		54.0
56.0												55.3 m/2.4				2.4		56.0
58.0																2.2		58.0
60.0																58.3 m/2.1		60.0
Reeves	2	2	2	2	2	2	2	2	2	2	2	2	2	2	2	2	2	Reeves

48.6 m Tower Length	48.6																	
	Tower length (m)	48.6												Tower length (m)				
	Jib length (m)	35.1				38.1				41.1				44.2				Jib length (m)
	Tower angle	90°	80°	70°	60°	90°	80°	70°	90°	80°	70°	90°	80°	70°	Tower angle			
12.0	12.5 m/16.5				13.3 m/13.6										12.0			
14.0	16.2				13.6			14.1 m/10.7			14.9 m/9.1				14.0			
15.0	15.9				13.3			10.7			9.1				15.0			
16.0	15.7				13.1			10.5			8.9				16.0			
18.0	15.2				12.7			10.1			8.6				18.0			
20.0	14.8				12.3			9.8			8.3				20.0			
22.0	13.6				11.9			9.5			8.0				22.0			
24.0	12.5				11.5			9.2			7.7				24.0			
26.0	11.5	26.7 m/11.2			11.1			8.9			7.4				26.0			
28.0	10.7	10.7			10.5	10.7		8.6	29.3 m/9.8		7.2				28.0			
30.0	9.4	10.0			9.6	10.0		8.3	9.6		6.9	30.6 m/8.0			30.0			
32.0	8.1	9.3			8.5	9.3		7.8	9.2		6.7	7.8			32.0			
34.0	6.7	8.8			7.4	8.8		7.3	8.8		6.4	7.6			34.0			
36.0	5.3	8.3			6.3	8.3		6.8	8.3		6.0	7.3			36.0			
38.0	37.1 m/4.1	7.8			5.1	7.8		6.2	7.8		5.6	7.1			38.0			
40.0		7.5	40.1 m/5.7		3.8	7.5	41.8 m/5.2	5.2	7.3		5.2	6.9			40.0			
42.0		7.1	5.3		40.1 m/3.5	6.9	5.2	4.1	6.8	43.6 m/4.8	4.8	6.7			42.0			
44.0		6.5	5.1			6.5	5.0	43.0 m/3.2	6.4	4.7	4.0	6.2	45.3 m/4.4		44.0			
46.0		45.6 m/5.4	4.8			6.0	4.7		5.9	4.6	2.8	5.8	4.3		46.0			
48.0			4.5			5.5	4.4		5.5	4.3		5.5	4.1		48.0			
50.0			4.2			48.5 m/4.7	4.1		5.1	4.0		5.1	3.9		50.0			
52.0			4.0	52.3 m/2.4			3.8		51.4 m/4.3	3.7		4.7	3.6		52.0			
54.0			53.7 m/3.5	2.3			3.6			3.5		4.3	3.4		54.0			
56.0				2.2			3.4			3.3		54.4 m/3.8	3.1		56.0			
58.0				2.1			56.6 m/3.3			3.0			2.9		58.0			
60.0				2.0						59.6 m/2.8			2.7		60.0			
62.0													2.5		62.0			
64.0													62.5 m/2.4		64.0			
Reeves	2	2	2	2	2	2	2	2	2	2	2	2	2	2	Reeves			

Note:
 Ratings according to Japanese Construction Codes for Mobile Cranes and Japanese Safety Ordinance on Cranes, etc.
 Ratings shown in are determined by the strength of the tower or other structural components.
 Refer to notes P19 and P20.

HYDRAULIC CRAWLER CRANE

7120

Unit: metric ton

Counterweight: 52.3 t

51.7 m Tower Length

Working radius (m)	51.7																Working radius (m)
	22.9				25.9				29.0				32.0				
	Tower length (m)	Jib length (m)			Tower length (m)	Jib length (m)			Tower length (m)	Jib length (m)			Tower length (m)	Jib length (m)			
Tower angle	90°	80°	70°	60°	90°	80°	70°	60°	90°	80°	70°	60°	90°	80°	70°	60°	Tower angle
9.4	20.0																9.4
10.0	20.0				10.2 m/20.0				11.0 m/20.0				11.8 m/18.6				10.0
12.0	20.0				20.0				19.4				18.6				12.0
14.0	20.0				19.2				18.2				17.4				14.0
15.0	20.0				18.6				17.7				16.8				15.0
16.0	18.7				18.1				17.2				16.4				16.0
18.0	16.6				16.6				16.3				15.5				18.0
20.0	15.0				15.0				15.0				14.7				20.0
22.0	13.6	22.1 m/13.5			13.6	23.4 m/12.8			13.6				13.6				22.0
24.0	10.4	12.5			12.5	12.5			12.5	24.7 m/12.1			12.5	25.9 m/11.5			24.0
26.0	25.4 m/7.6	11.5			10.0	11.5			11.4	11.5			11.5	11.5			26.0
28.0		10.7			7.2	10.7			9.4	10.7			10.3	10.7			28.0
30.0		10.0			28.3 m/6.5	10.0			7.3	10.0			8.7	10.0			30.0
32.0		9.3				9.3			31.2 m/5.5	9.3			7.1	9.3			32.0
34.0		8.8	34.1 m/7.3			8.8	35.9 m/6.6			8.8			5.2	8.8			34.0
36.0		34.3 m/8.7	6.7			8.3	6.5			8.3	37.6 m/6.0		34.2 m/4.8	8.3			36.0
38.0			6.3			37.3 m/8.2	6.2			7.6	5.9			7.8	39.4 m/5.4		38.0
40.0			5.9				5.8			6.9	5.7			7.4	5.4		40.0
42.0			5.5				5.4			40.2 m/6.8	5.3			6.8	5.2		42.0
44.0			42.9 m/5.2	45.2 m/3.3			5.1				5.0			43.1 m/6.2	4.9		44.0
46.0				3.2			45.9 m/4.8	47.3 m/3.0			4.7				4.6		46.0
48.0				3.1				2.9			4.4	49.5 m/2.6			4.3		48.0
50.0				2.9				2.8			48.8 m/4.2	2.6		4.0	51.6 m/2.2		50.0
52.0				51.0 m/2.8				2.6				2.5			51.8 m/3.7	2.2	52.0
54.0								53.9 m/2.4				2.3				2.1	54.0
56.0												2.1				2.0	56.0
58.0												56.8 m/2.0					58.0
Reeves	2	2	2	2	2	2	2	2	2	2	2	2	2	2	2	2	Reeves

Working radius (m)	51.7												Working radius (m)
	35.1			38.1			41.1			44.2			
	Tower length (m)	Jib length (m)		Tower length (m)	Jib length (m)		Tower length (m)	Jib length (m)		Tower length (m)	Jib length (m)		
Tower angle	90°	80°	70°	90°	80°	70°	90°	80°	70°	90°	80°	70°	Tower angle
12.0	12.5 m/16.5			13.3 m/13.6									12.0
14.0	16.2			13.6			14.1 m/10.7			14.9 m/9.1			14.0
15.0	15.9			13.3			10.7			9.1			15.0
16.0	15.6			13.1			10.5			8.9			16.0
18.0	14.7			12.6			10.1			8.6			18.0
20.0	14.0			12.2			9.8			8.3			20.0
22.0	13.4			11.9			9.5			8.0			22.0
24.0	12.5			11.5			9.1			7.7			24.0
26.0	11.5	27.2 m/10.7		11.1			8.9			7.4			26.0
28.0	10.7	10.3		10.4	28.5 m/10.0		8.6	29.8 m/8.5		7.1			28.0
30.0	9.4	9.9		9.6	9.1		8.3	8.5		6.9	31.1 m/8.0		30.0
32.0	8.1	9.3		8.5	8.8		7.8	8.2		6.7	7.6		32.0
34.0	6.8	8.8		7.4	8.5		7.3	7.9		6.4	7.3		34.0
36.0	5.3	8.3		6.3	8.2		6.8	7.6		6.0	7.1		36.0
38.0	37.1 m/4.2	7.8		5.2	7.7		6.3	7.4		5.6	6.8		38.0
40.0		7.3	41.1 m/4.9	3.8	7.1		5.2	7.0		5.2	6.6		40.0
42.0		6.8	4.9	40.1 m/3.5	6.6	42.9 m/4.4	4.1	6.5		4.8	6.4		42.0
44.0		6.3	4.8		6.2	4.4	43.0 m/3.2	6.1	44.6 m/4.2	4.0	5.9		44.0
46.0		5.7	4.5		5.7	4.3		5.7	4.0	2.8	5.5	46.4 m/3.8	46.0
48.0		46.1 m/5.4	4.2		5.3	4.0		5.3	3.8		5.2	3.6	48.0
50.0			3.9	49.0 m/4.7	3.7		4.9	3.6		4.8	3.4		50.0
52.0			3.6		3.5		4.3	3.3		4.5	3.2		52.0
54.0			3.4		3.2			3.1		4.2	3.0		54.0
56.0			54.7 m/3.3		3.0		2.9		54.9 m/3.8	2.8			56.0
58.0					57.6 m/2.8			2.7			2.6		58.0
60.0								2.5			2.4		60.0
62.0								60.6 m/2.4			2.2		62.0
64.0											63.5 m/2.0		64.0
Reeves	2	2	2	2	2	2	1	1	1	1	1	1	Reeves

Note:
 Ratings according to Japanese Construction Codes for Mobile Cranes and Japanese Safety Ordinance on Cranes, etc.
 Ratings shown in are determined by the strength of the tower or other structural components.
 Refer to notes P19 and P20.

PARTS AND ATTACHMENTS

Base Machine

With gantry, lower boom, carbody, lower spreader and upper spreader
Weight: 36,785 kg Width: 3,200 mm

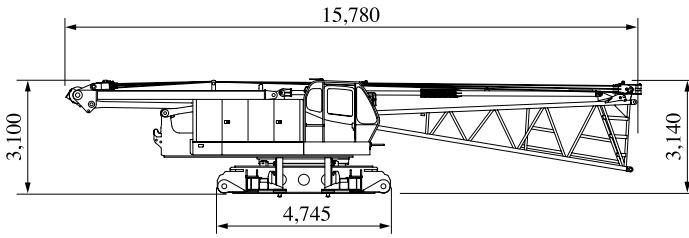

Base Machine

With gantry and carbody
Weight: 33,200 kg Width: 3,200 mm

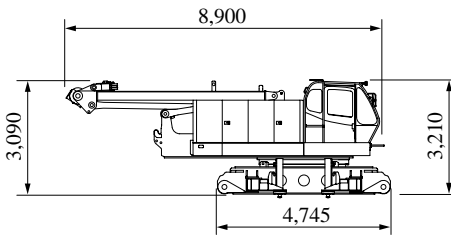

Crawler

Weight: 14,500 kg

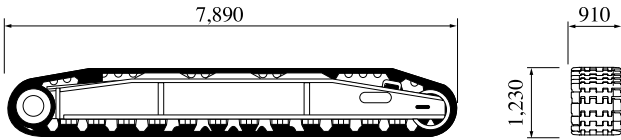

Gantry

Weight: 2,200 kg

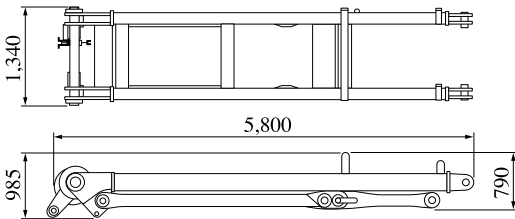

Boom Top (with 3.0 m tapered boom)

Weight: 2,530 kg (with boom guy cables)

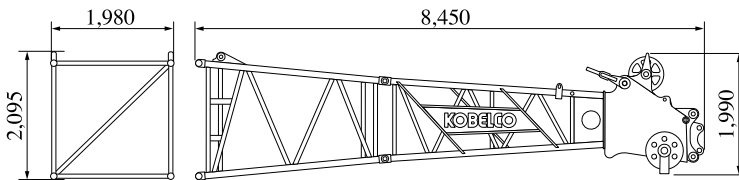

Boom Base (with tower backstop)

Weight: 3,100 kg

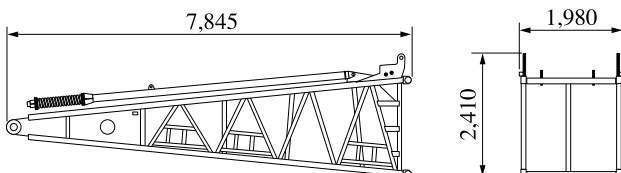

Insert Boom

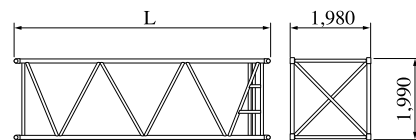

	L (mm)	Weight (kg)*
3.0m	3,180	630
6.1m	6,230	1,000
9.1m	9,270	1,360

*with boom guy cables

Counterweight A

Weight: 9,900 kg

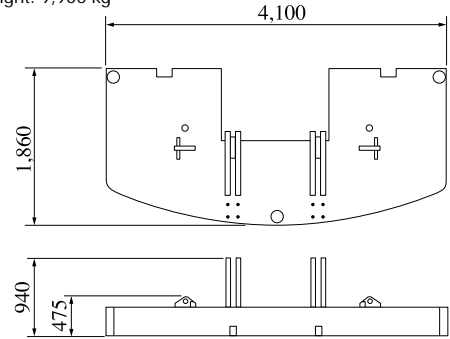

Counterweight B, C

Weight: 10,000 kg x 2 pieces

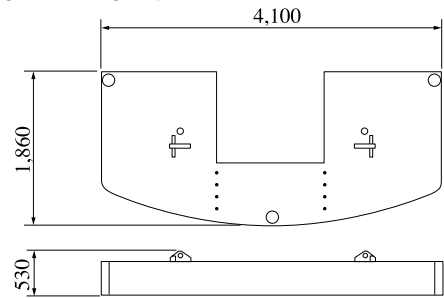

Counterweight D

Weight: 9,300 kg

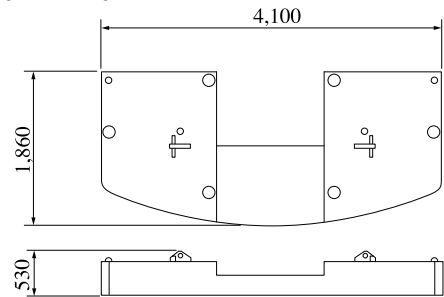

Counterweight E

Weight: 6,500 kg

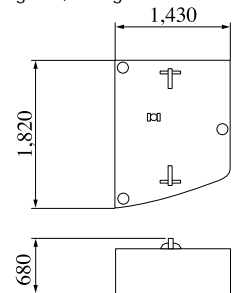

Counterweight F

Weight: 6,300 kg

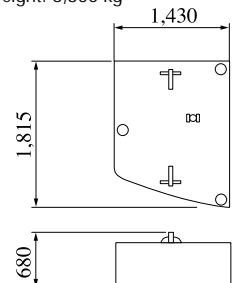

Dimensions: mm Weight: kg

Jib Top (For Crane)

Weight: 315 kg

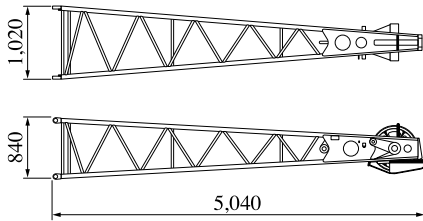

Tower Jib Top

Weight: 900 kg

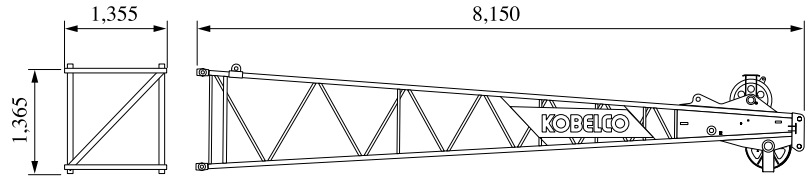

Jib Base (For Crane)

Weight: 210 kg

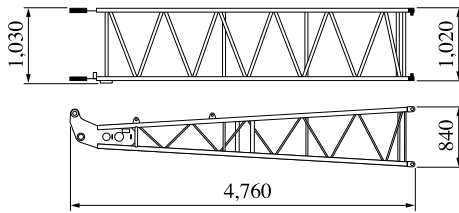

Tower Jib Base

Weight: 1,200 kg

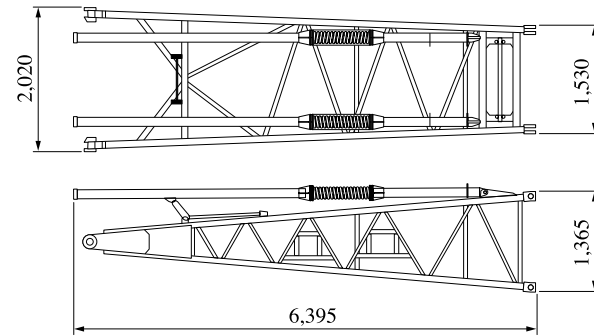

Tower Cap

Weight: 1,780 kg

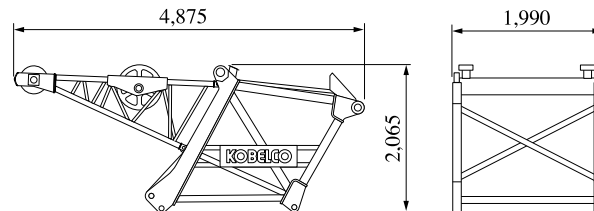

Other Attachments

Attachments	Weight	Dimensions (L x W x H)
9.1A special insert boom for tower	1,740 kg (with guy cables)	9,270 mm x 1,980 mm x 2,790 mm
3.0A relay jib	230 kg	3,145 mm x 1,530 mm x 1,365 mm
3.0 m tower insert jib	210 kg	3,145 mm x 1,355 mm x 1,365 mm
6.1 m tower insert jib	360 kg	6,195 mm x 1,355 mm x 1,365 mm
9.1 m tower insert jib	510 kg	9,240 mm x 1,355 mm x 1,365 mm
3.0 m insert jib (for crane)	110 kg	3,130 mm x 1,020 mm x 840 mm
6.1 m insert jib (for crane)	190 kg	6,175 mm x 1,020 mm x 840 mm
Tower jib strut	1,355 kg	5,925 mm x 2,065 mm x 915 mm
Crane jib strut	300 kg	5,130 mm x 1,040 mm x 615 mm
Crane backstop	210 kg (1 piece)	6,265 mm x 115 mm dia. x 210 mm
Tower backstop	420 kg (1 piece)	6,200 mm x 140 mm dia. x 235 mm
Upper spreader	485 kg	2,045 mm x 365 mm x 880 mm
Lower spreader	315 kg	1,150 mm x 300 mm x 930 mm
Upper spreader for tower jib	310 kg	925 mm x 730 mm x 1,170 mm
Lower spreader for tower jib	410 kg	1,940 mm x 460 mm x 1,070 mm
120-ton hook	1,700 kg	710 mm x 700 mm x 1,930 mm
70-ton hook	1,200 kg	470 mm x 700 mm x 1,825 mm
35-ton hook	900 kg	365 mm x 700 mm x 1,575 mm
Ball hook	450 kg	380 mm dia. x 1,200 mm

Note: Estimated weights may vary $\pm 2\%$.



HYDRAULIC CRAWLER CRANE

7120

Standard Equipment

Upper structure/Lower structure

Counterweight: 52.3 ton (total weight)
 910 mm shoe crawlers
 Batteries (2-12V, 136 Ah/5HR)
 Trans-lifter (jack system)
 Travel kit
 Gantry raising/lowering cylinder
 Electric hand throttle grip
 Variable boom hoist speed controller
 Variable main/aux. hoist speed controller
 Swing neutral-free/brake select switch
 Side deck for cab
 Steps (crawlers)
 Two front working lights
 Two rear view mirrors
 Tools (for routine maintenance)
 Upper spreader storage guide

Cab/Control

Air conditioner
 Luggage box
 Cup holder
 Ashtray
 Cigar lighter
 Intermittent wiper & window washer (skylight and front window)
 Sun visor
 Roof blind
 Floor mat (cloth)
 Foot rest
 Shoe tray

Safety Device

Load Moment Indicator (with boom lowering slow stop function)
 LMI release key (for hook over-hoist prevention device and boom over-hoist prevention device)
 LCD multi display
 Ultimate stop function for boom over-hoist
 Function lock lever
 Propel lever lock
 Mechanical drum lock pawl (main, aux. and boom hoist)
 Signal horn
 Swing parking brake
 Mechanical swing lock pin (four positions)
 Swing flashers/warning buzzer

Note: Standard equipment may vary depending on your areas or countries.

Due to our policy of continual product improvements all designs and specifications are subject to change without advance notice.

Copyright by KOBELCO CRANES CO., LTD. No part of this catalog may be reproduced in any manner without notice.

KOBELCO CRANES CO., LTD.

17-1, Higashigotanda 2-chome, Shinagawa-ku, Tokyo 141-8626 JAPAN
 Tel: +81-3-5789-2130 Fax: +81-3-5789-3372

Inquiries To:

KOBELCO is the corporate mark used by Kobe Steel on a variety of products and in the names of a number of Kobe Steel Group companies.